



Product Catalog

2026

Playground Accessories

Playsan's New Playground Equipment
Meet the 2026 Catalog



+90 530 771 71 49
+90 530 185 67 89



www.playsan.com



Büyükkayacık OSB,
Yaylacık Cd. No:34,
42210 Selçuklu/Konya



PLAYSAN PLAYGROUNDS

Design, Security and Entertainment All in One

Playsan is a playground equipment manufacturer that combines an engineering perspective with the world of children.

From design to production, the company prioritizes quality, safety, and sustainability throughout every stage of the process. Today, Playsan products—the preferred choice in many countries—provide children with safe play areas while enhancing the aesthetic appeal of cities.

Each project is specially designed and meticulously crafted to nurture children's imagination. With its innovative solutions and eco-friendly materials, Playsan creates not only playgrounds but also living spaces that add value to communities.

By prioritizing safety and quality in every detail, it offers unforgettable experiences for both children and families.



Games that reach around the world

At Playsan, with our export capabilities extending to over 40 countries, we confidently deliver playground equipment to the world. The playgrounds we produce—tailored to different geographies while maintaining consistent quality, safety, and design standards—form the foundation of our global brand vision.

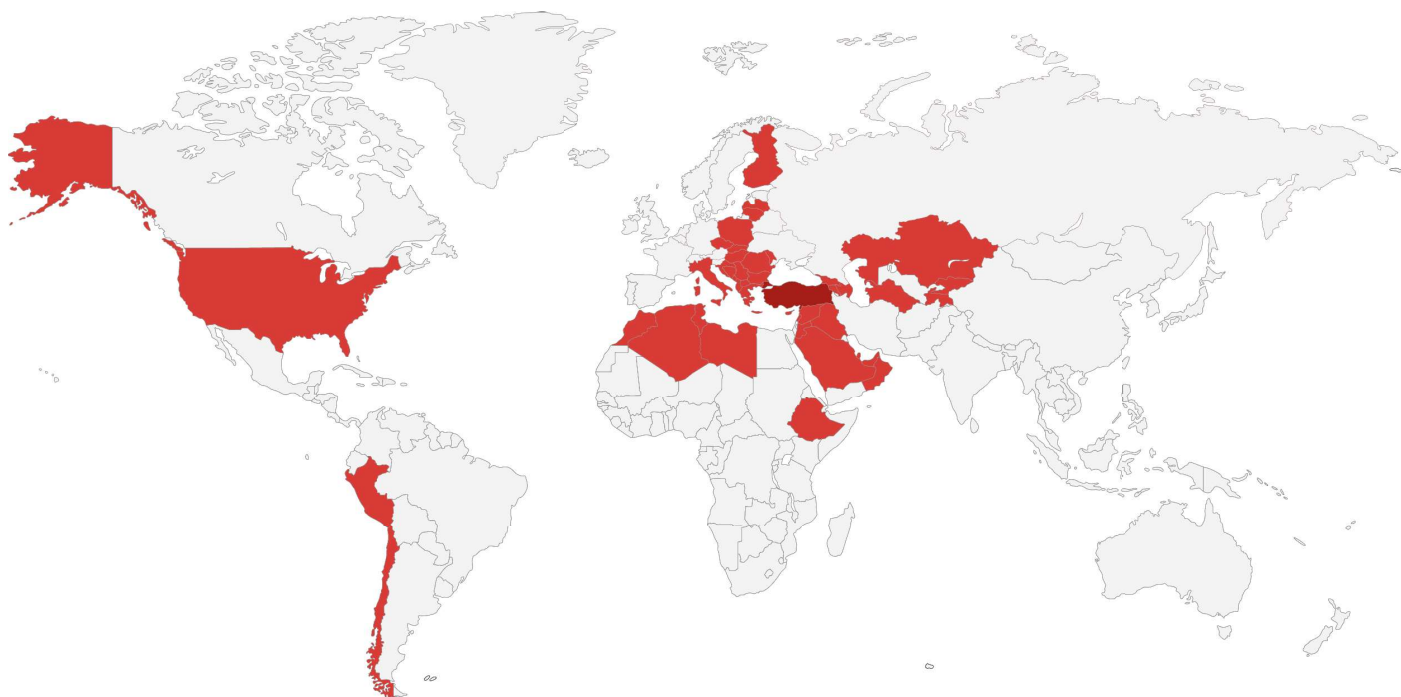

Albania
Azerbaijan
United Arab Emirates
Bosnia And Herzegovina
Bulgaria
Czech Republic
Ethiopia
Morocco
Peru

Finland
Georgia
Croatia
Iraq
Italy
Montenegro
Qatar
Kazakhstan

Kyrgyzstan
Kosovo
Latvia
Libya
Lithuania
Lebanon
Hungary
North Macedonia

Malta
Moldova
Poland
Romania
Serbia
Slovakia
Saudi Arabia
Syria

Chile
Tunisia
Turkmenistan
Oman
United States
Jordan
Greece
Tajikistan



Production at International Standards



With our production philosophy centered on quality and safety, we develop our products in accordance with ISO and EN standards. We offer assurance with ISO 9001:2008, ISO 14001:2004, OHSAS 18001:2007, TS EN 1176 series, TS 12427, TS EN 16630 and TSEK certificates.

We manufacture according to international standards.

At Playsan, we conduct all our production processes in accordance with international quality, environmental, and occupational safety standards. Our products are developed with durability, safety, and long-lasting use in mind at every step, from design and production to material selection and final inspection.

With our approach that prioritizes children's safety in playgrounds, we produce solutions compliant with TS EN 1176 standards and offer durable and sustainable products suitable for outdoor conditions. Thanks to our quality management systems, we aim to maintain the same high standard in every project with stable production, controlled processes, and a reliable supply chain.



Our Production Stages



Laser Cutting

This process involves cutting the metal and sheet metal used in our products to the specified standard dimensions.

Sheet Metal Bending

This process involves shaping the sheet metal to be used in playground equipment using a press brake and appropriate dies at specific angles.



MIG Welding

It is a type of welding used to join different parts on metal workbenches.

Sandblasting

It is a surface cleaning method used to remove rust, dirt, grease, and welding slag from metal surfaces. This process is applied to all metal products.



Electrostatic Painting

All metals used in the playground equipment are coated with electrostatic powder paint. This process not only gives the products an attractive appearance but also ensures they remain protected against all weather conditions for many years.

Plastisol Coating

Plastisol coating is used to soften sharp surfaces that children may come into contact with, protect metals from corrosion, and prevent floors from becoming slippery.





Raw Material Line

Pure polyethylene raw material undergoes specific processing steps. Additives and pigments that prevent color fading and provide protection against UV rays are added, and the mixture is homogenized in a mixer to make it ready for production.

Plastic Material Production (Rotational Molding)

The raw materials, once prepared for production, are poured into molds and baked under controlled conditions in rotary kilns to produce the final product.

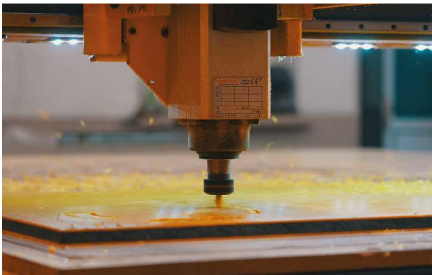

Router Processing

This involves engraving, shaping, creating reliefs, and etching on materials such as HPL and HDPE.

Woodworking

In our woodworking processes, products such as gazebos, benches, and picnic tables are crafted with a focus on durability and aesthetics. The selected wood materials are shaped using modern woodworking techniques.



Rope and Connection Systems

Rope and Connection Systems; High-strength ropes and connectors are secured using a hydraulic press and joined in a way that cannot be undone.

Shipment

Our products are securely packaged and meticulously prepared throughout the shipping process to ensure they arrive without damage. Supported by a well-structured logistics system, all deliveries are carried out on time and in complete quantities.



Now it's game time!

For children, time gains meaning through play.

The spaces where they dream, explore, and move freely expand their world.

The playgrounds we design at Playsan are here for safe, creative, and fun-filled moments.

Come on...
The time has come.
Now it's **playtime**.

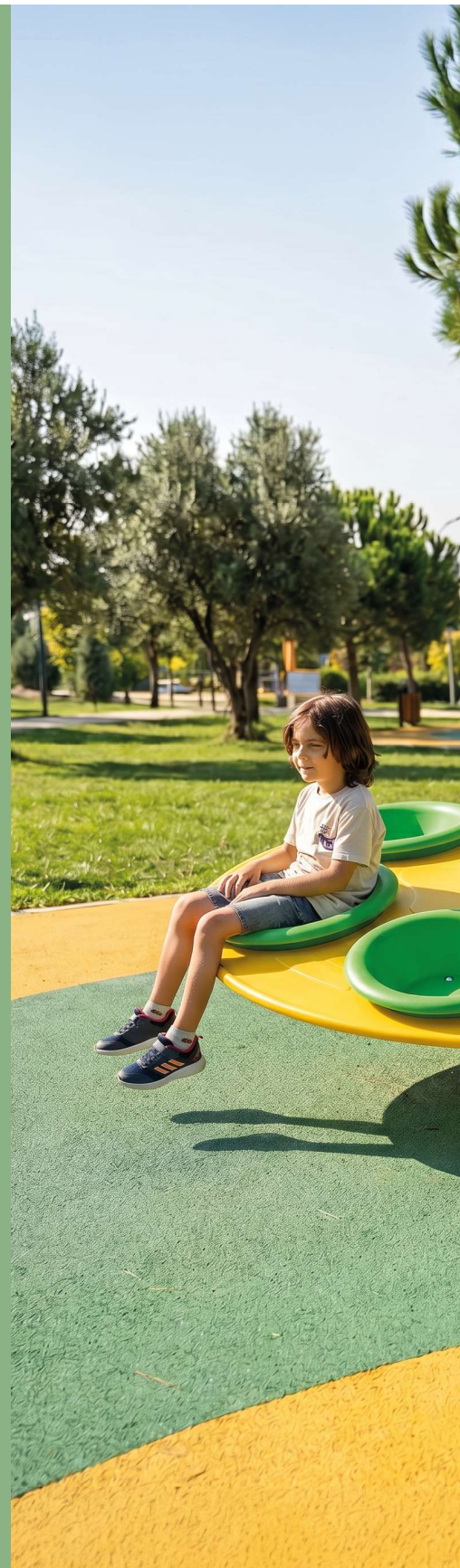



Contents

NEW GENERATION PLAYGROUNDS EQUIPMENTS	10-25
MERRY GO SERIES	26-31
SWING SERIES	32-39
SEESAW SERIES	40-45
SPRINGER SERIES	46-55
CLIMBING SERIES	56-59
TRAMPOLINE SERIES	60-61
SURVIVOR SERIES	62-65



NEW GENERATION PLAYGROUNDS EQUIPMENTS

Unlike ordinary playgrounds, New Generation Play Equipment consists of modern, thoughtfully designed series that encourage children to be more active and creative while teaching them risk management. These series are designed to help children develop their sensory experiences.



PR-01

Age Range: 3-14
 Number Of Users: 3+
 Product Dimensions: 316X316X78cm
 Free-Fall Height: 78cm

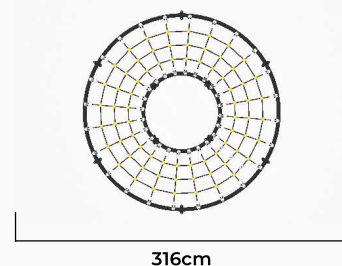

PR-02

Age Range: 3-14
 Number Of Users: 2+
 Product Dimensions: 226X85X206cm
 Free-Fall Height: 206cm

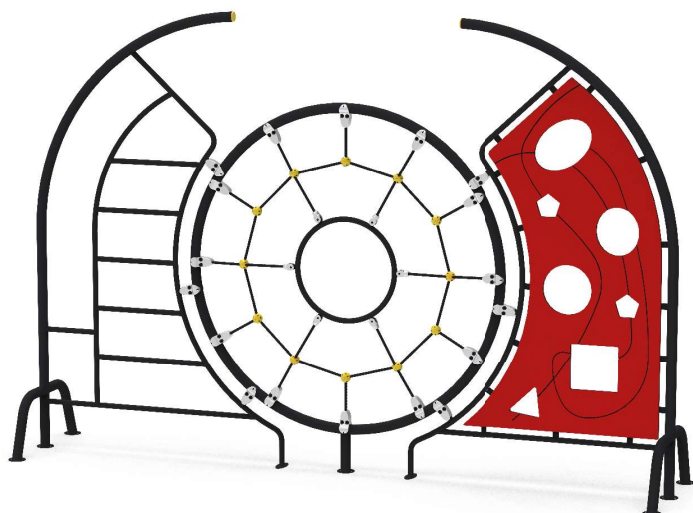
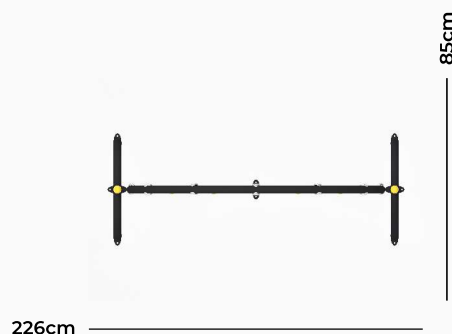

PR-03

Age Range: 3-14
 Number Of Users: 4+
 Product Dimensions: 401X89X269cm
 Free-Fall Height: 218cm

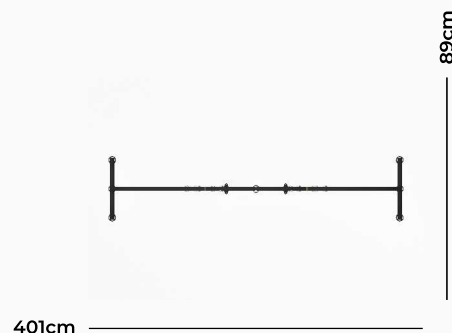



PR-04

Age Range: 3-14
 Number Of Users: 8+
 Product Dimensions: 516X289X222cm
 Free-Fall Height: 222cm

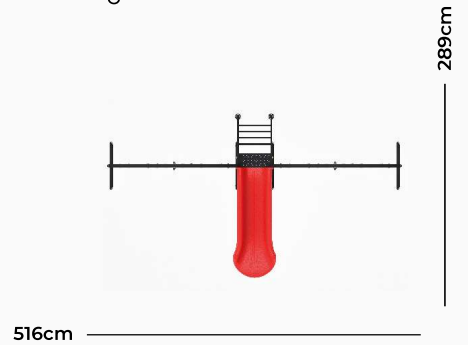

PR-05

Age Range: 3-14
 Number Of Users: 5+
 Product Dimensions: 260X257X254cm
 Free-Fall Height: 254cm

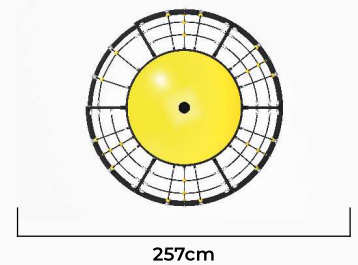

PR-06

Age Range: 3-14
 Number Of Users: 3+
 Product Dimensions: 155X155X200cm
 Free-Fall Height: 200cm

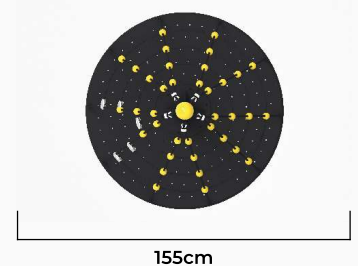



PR-07

Age Range: 3-14
 Number Of Users: 3+
 Product Dimensions: 200X200X258cm
 Free-Fall Height: 258cm



PR-08

Age Range: 3-14
 Number Of Users: 3+
 Product Dimensions: 196X196X288cm
 Free-Fall Height: 288cm

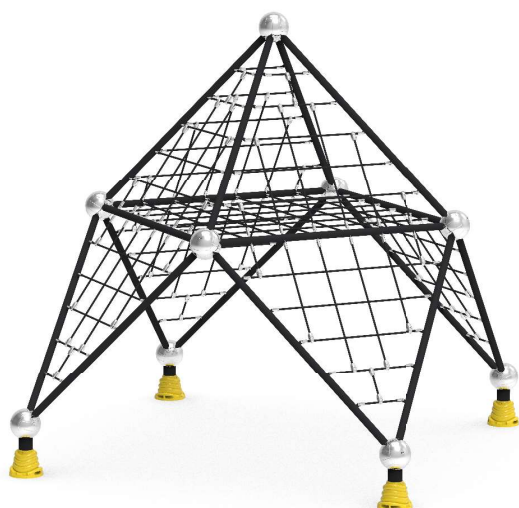
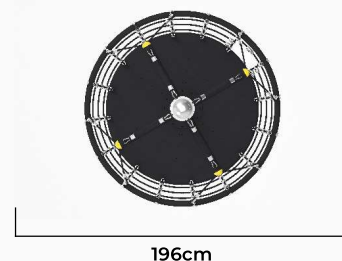

PR-09

Age Range: 3-14
 Number Of Users: 6+
 Product Dimensions: 341X341X368cm
 Free-Fall Height: 368cm

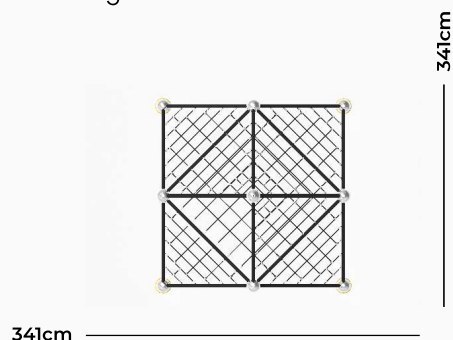

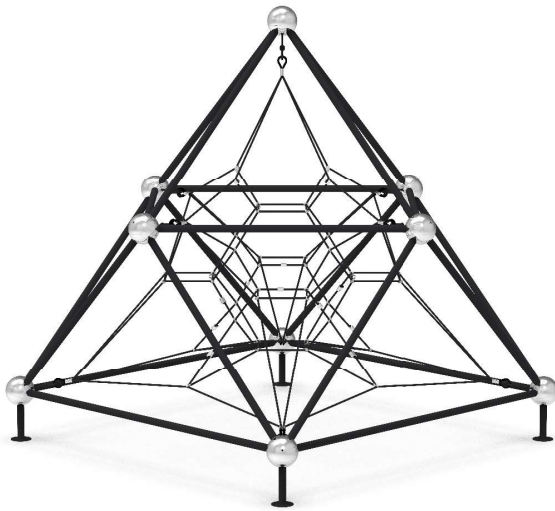

PR-10

Age Range: 3-14
 Number Of Users: 6+
 Product Dimensions: 341X341X370cm
 Free-Fall Height: 370cm

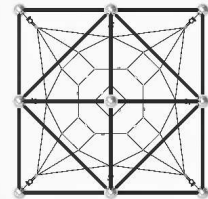

341cm

341cm

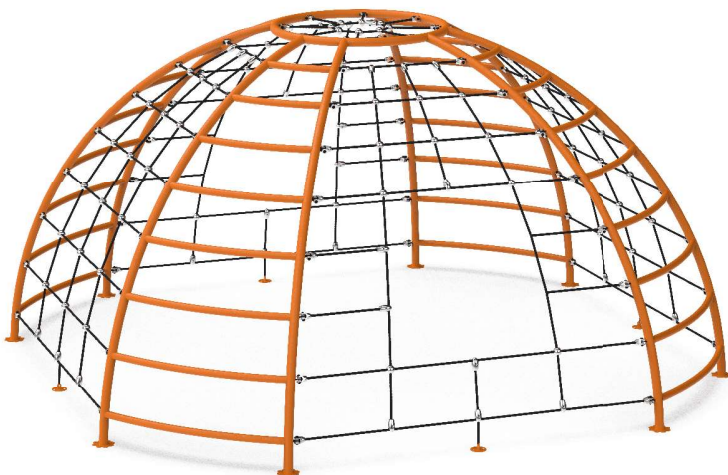

PR-11

Age Range: 3-14
 Number Of Users: 11+
 Product Dimensions: 465X465X243cm
 Free-Fall Height: 243cm

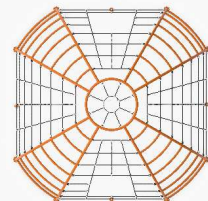

465cm

465cm

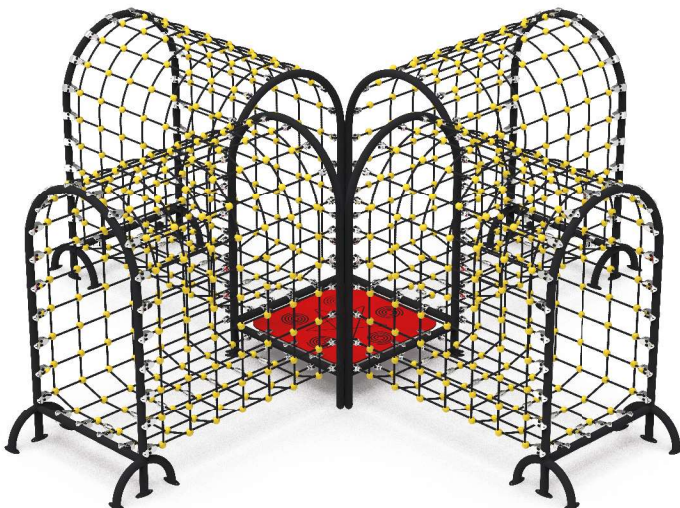

PR-12

Age Range: 3-14
 Number Of Users: 11+
 Product Dimensions: 558X558X212cm
 Free-Fall Height: 212cm

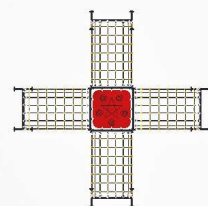

558cm

558cm



PR-13

Age Range: 3-14
 Number Of Users: 11+
 Product Dimensions: 720X635X190cm
 Free-Fall Height: 190cm

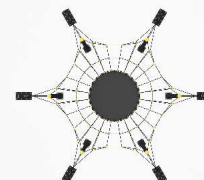

720cm

635cm



PR-14

Age Range: 3-14
 Number Of Users: 7+
 Product Dimensions: 700X261X319cm
 Free-Fall Height: 80cm

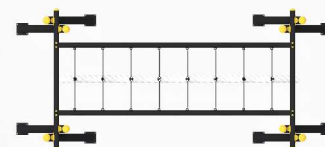

700cm

261cm

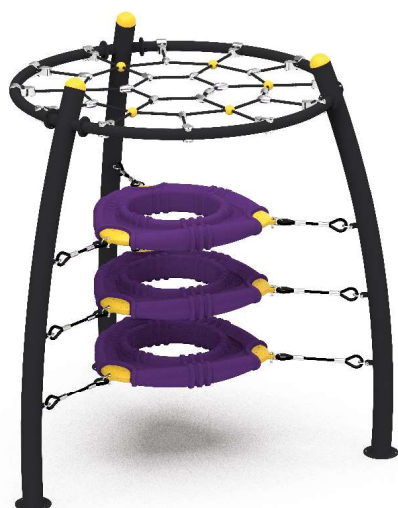

PR-15

Age Range: 3-14
 Number Of Users: 3+
 Product Dimensions: 227X227X233cm
 Free-Fall Height: 207cm

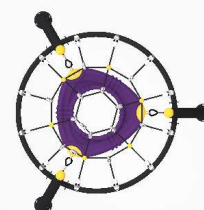

227cm



PR-16

Age Range: 3-14
 Number Of Users: 4+
 Product Dimensions: 228X145X268cm
 Free-Fall Height: 128cm

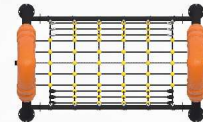

228cm

145cm



PR-17

Age Range: 3-14
 Number Of Users: 3+
 Product Dimensions: 378X144X274cm
 Free-Fall Height: 140cm

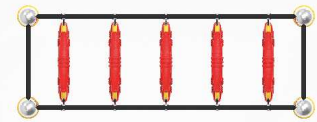

378cm

144cm



PR-18

Age Range: 3-14
 Number Of Users: 3+
 Product Dimensions: 439X160X270cm
 Free-Fall Height: 140cm

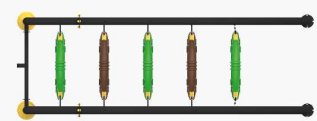

439cm

160cm

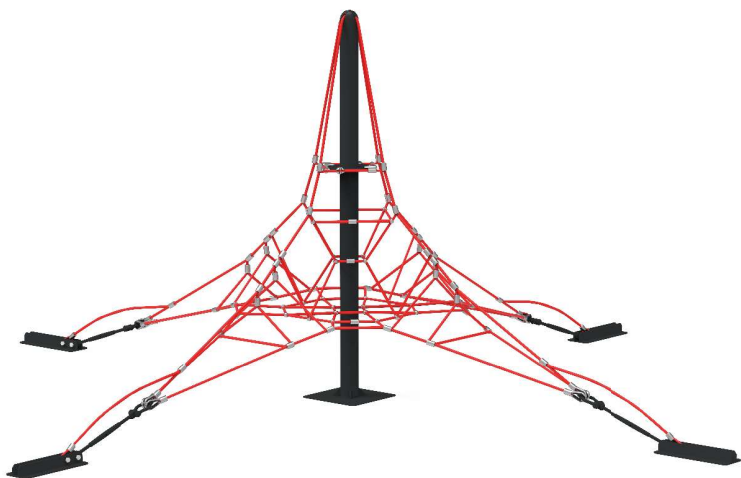

PR-19

Age Range: 3-14
 Number Of Users: 9+
 Product Dimensions: 700X700X290cm
 Free-Fall Height: 290cm

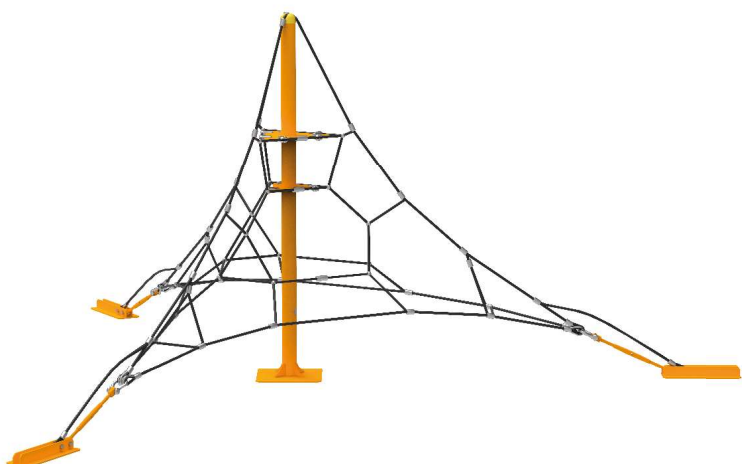
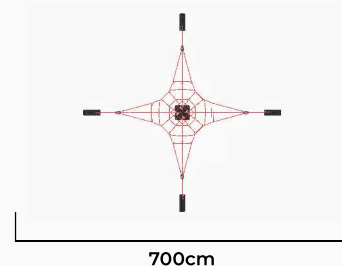

PR-20

Age Range: 3-14
 Number Of Users: 9+
 Product Dimensions: 615X535X280cm
 Free-Fall Height: 280cm

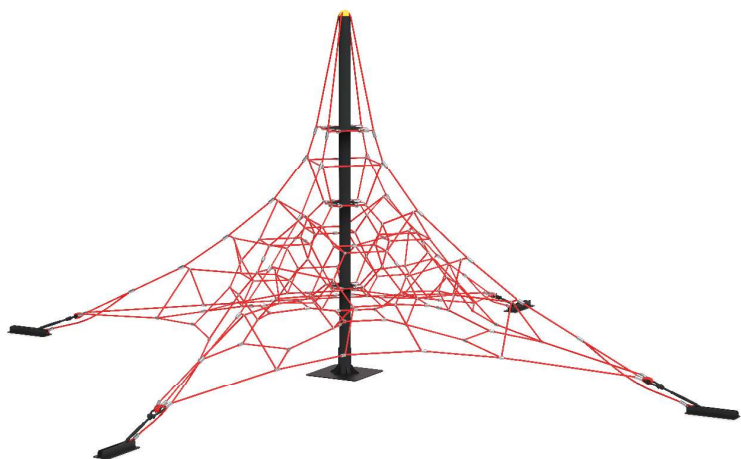
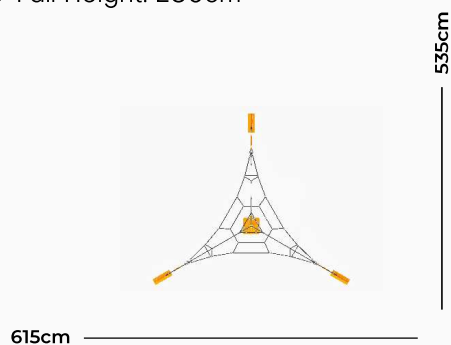

PR-21

Age Range: 3-14
 Number Of Users: 11+
 Product Dimensions: 1060X1060X440cm
 Free-Fall Height: 440cm

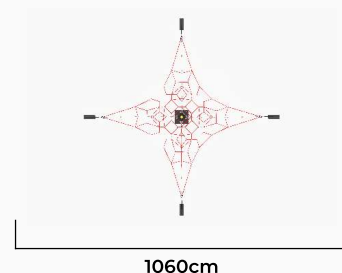

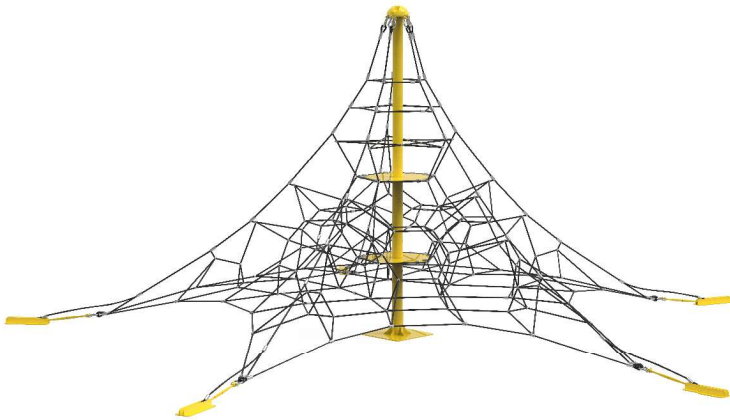

PR-22

Age Range: 3-14
 Number Of Users: 10+
 Product Dimensions: Ø1040X435cm
 Free-Fall Height: 435cm

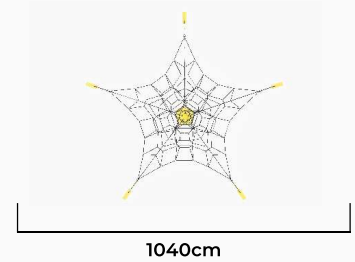

PR-23

Age Range: 3-14
 Number Of Users: 3+
 Product Dimensions: 300X145X271cm
 Free-Fall Height: 43cm

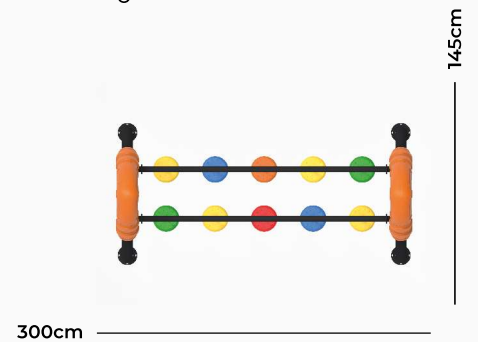

PR-24

Age Range: 3-14
 Number Of Users: 3+
 Product Dimensions: 328X144X256cm
 Free-Fall Height: 33cm

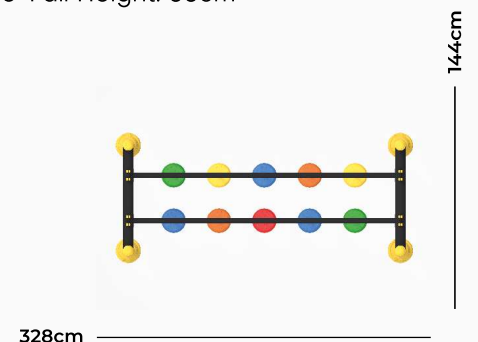



PR-25

Age Range: 3-14
Number Of Users: 6+
Product Dimensions: 403X403X225cm
Free-Fall Height: 225cm

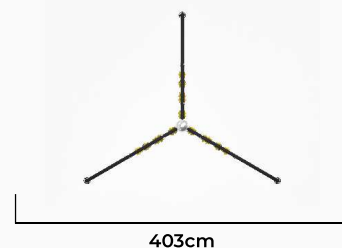

PR-26

Age Range: 3-14
Number Of Users: 3+
Product Dimensions: 187X187X306cm
Free-Fall Height: 306cm

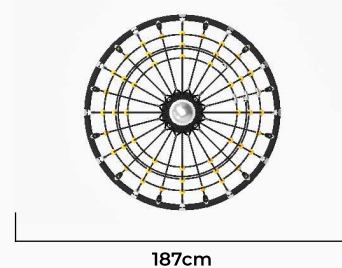

PR-27

Age Range: 3-14
Number Of Users: 3+
Product Dimensions: 197X197X301cm
Free-Fall Height: 128cm

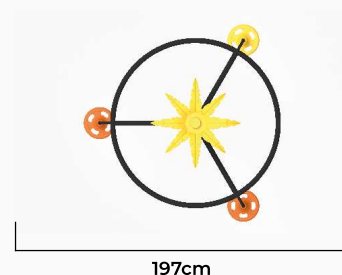

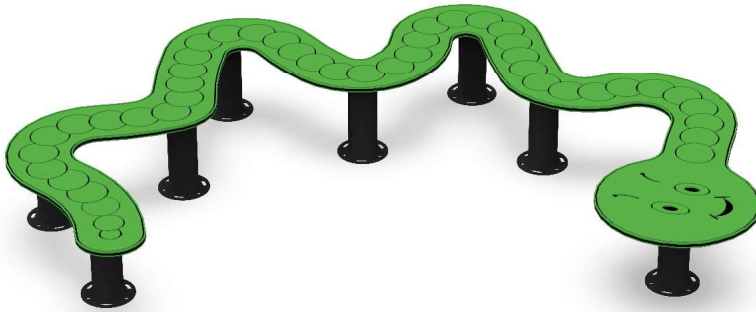

PR-28

Age Range: 3-14
Number Of Users: 6+
Product Dimensions: 277X195X35cm
Free-Fall Height: 35cm

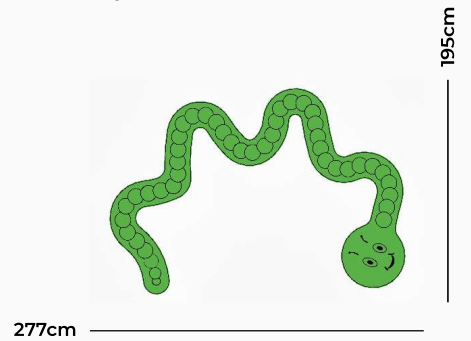

PR-N01

Age Range: 3-14
Number Of Users: 2+
Product Dimensions: 330X100X231cm
Free-Fall Height: 231cm

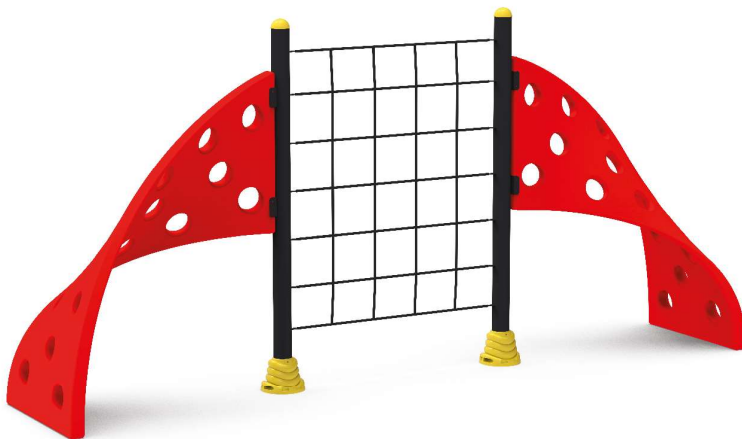
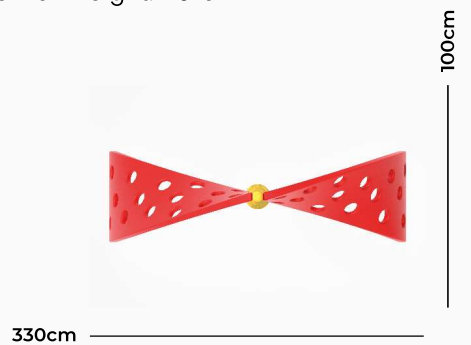

PR-N02

Age Range: 3-14
Number Of Users: 3+
Product Dimensions: 487X100X231cm
Free-Fall Height: 231cm

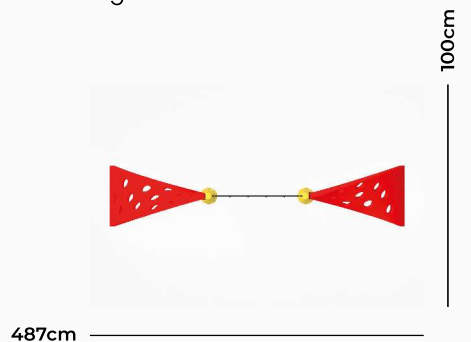

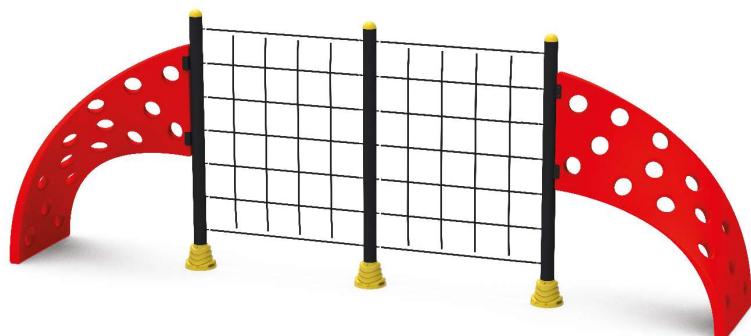

PR-N03

Age Range: 3-14
 Number Of Users: 4+
 Product Dimensions: 647X100X231cm
 Free-Fall Height: 231cm

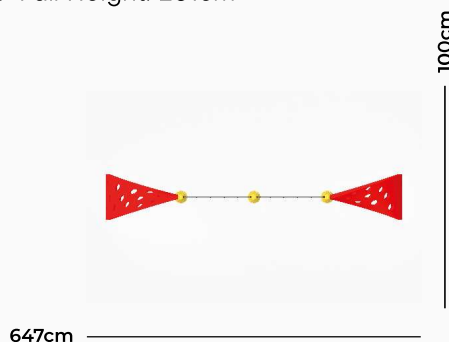

PR-N04

Age Range: 3-14
 Number Of Users: 3+
 Product Dimensions: Ø342X231cm
 Free-Fall Height: 231cm

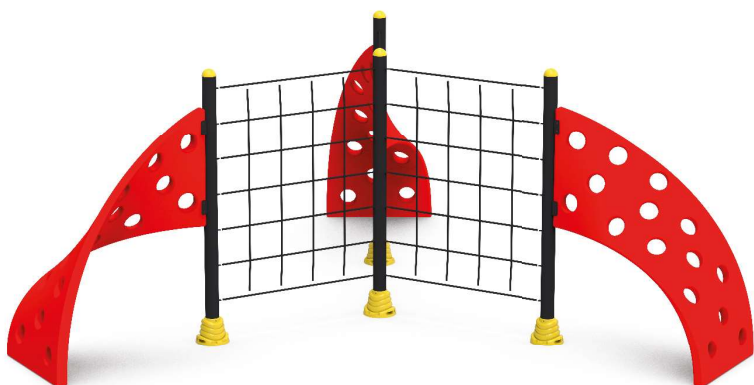
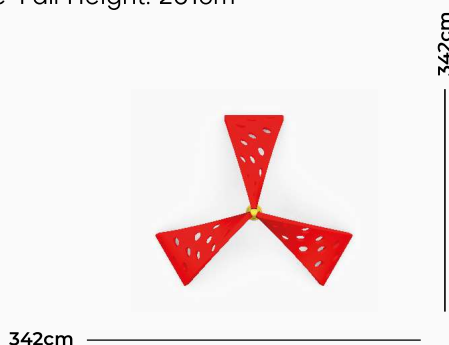

PR-N05

Age Range: 3-14
 Number Of Users: 5+
 Product Dimensions: Ø655X231cm
 Free-Fall Height: 231cm

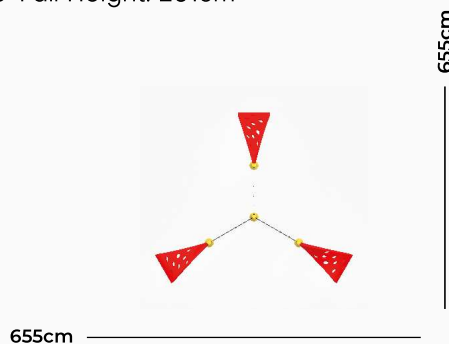

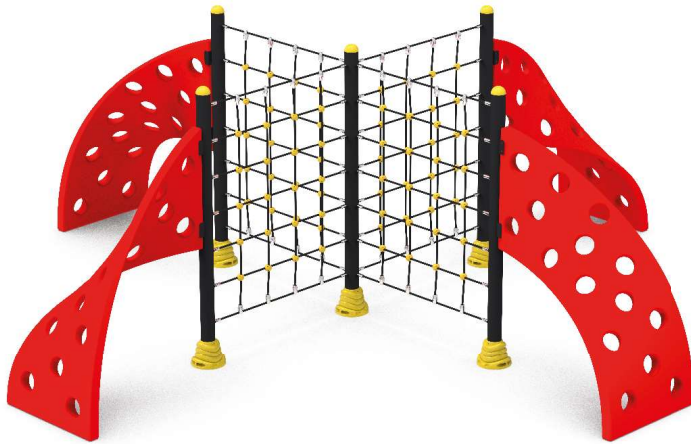

PR-N06

Age Range: 3-14
 Number Of Users: 8+
 Product Dimensions: Ø650X231cm
 Free-Fall Height: 231cm

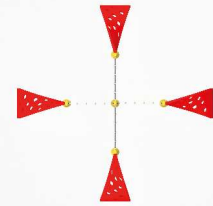

650cm

650cm

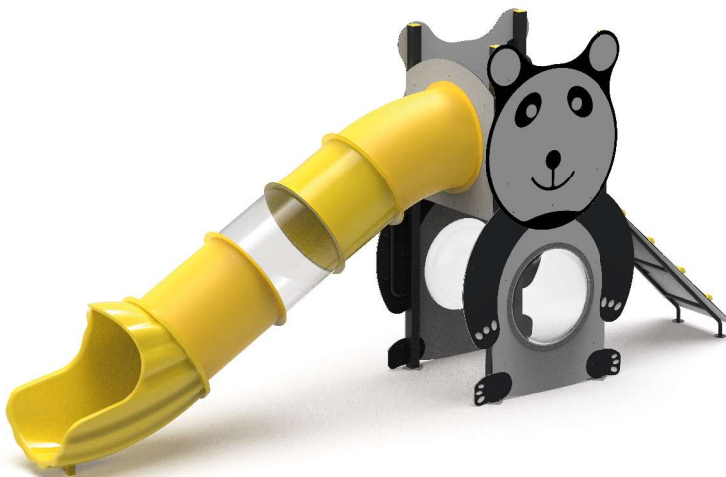

PR-N07

Age Range: 3-14
 Number Of Users: 3+
 Product Dimensions: 625X160X276cm
 Free-Fall Height: 150cm



625cm

160cm



PR-N08

Age Range: 3-14
 Number Of Users: 3+
 Product Dimensions: 555X75X150cm
 Free-Fall Height: 64cm



555cm

75cm



PR-N09

Age Range: 3-14
 Number Of Users: 2+
 Product Dimensions: 128X60X71cm
 Free-Fall Height: 40cm

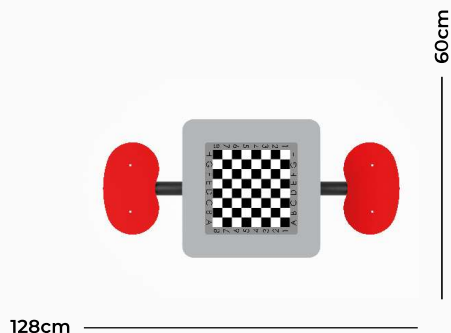

PR-N10

Age Range: 3-14
 Number Of Users: 3+
 Product Dimensions: 139X125X72cm
 Free-Fall Height: 42cm

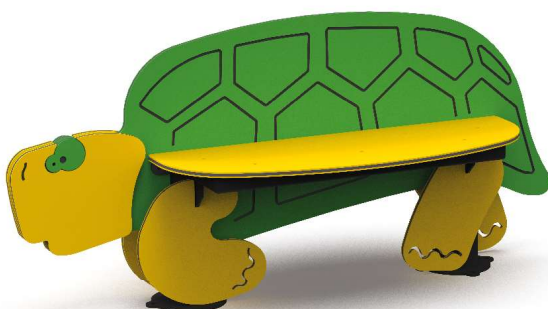
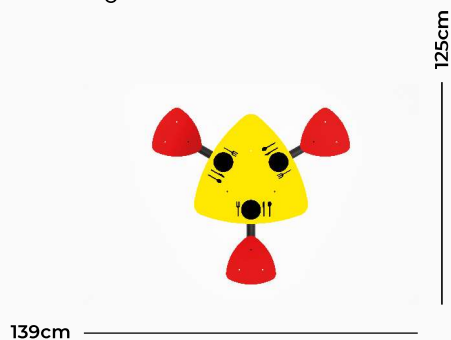

PR-N11

Age Range: 3-14
 Number Of Users: 2+
 Product Dimensions: 130X55X60cm
 Free-Fall Height: 34cm

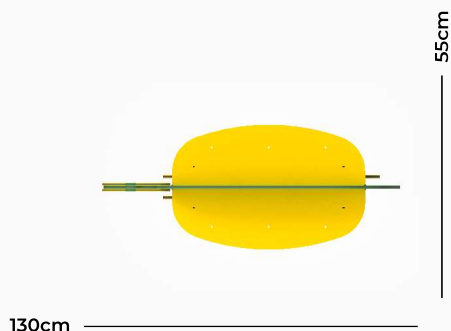

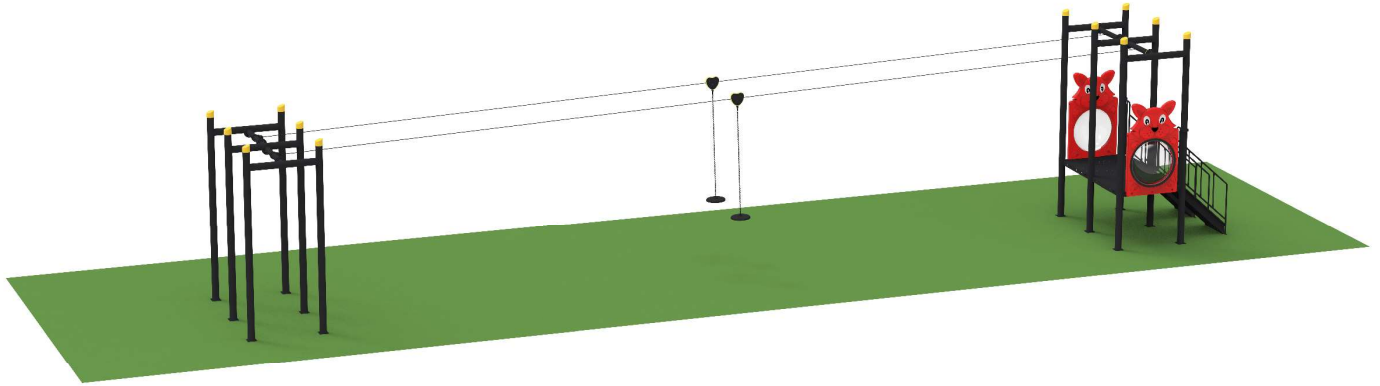

PR-N12

Age Range: 3-14

Number Of Users: 2+

Product Dimensions: 1722X247X366cm

Free-Fall Height: 130cm

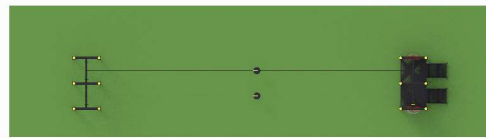

1722cm

247cm

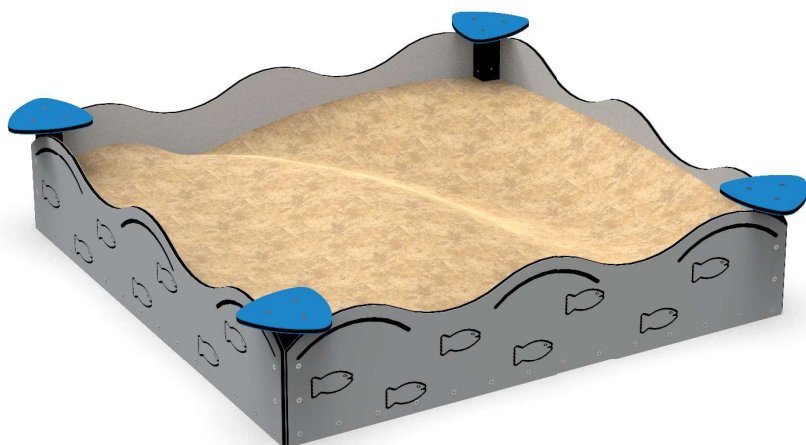

PR-N13

Age Range: 3-14

Number Of Users: 6+

Product Dimensions: 226X226X47cm

Free-Fall Height: 47cm

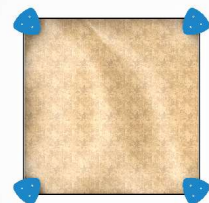

226cm

226cm





MERRY GO ROUND SERIES

Merry Go Round help children develop their sense of balance while encouraging them to view their surroundings from a different perspective. This aesthetically pleasing and modern series is designed to help children have fun and enjoy their time.

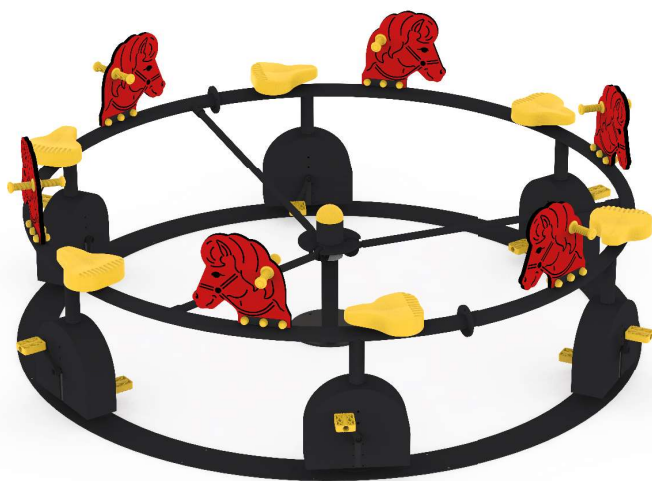

PC-D01

Age Range: 3-14
Number Of Users: 6+
Product Dimensions: Ø266X100cm

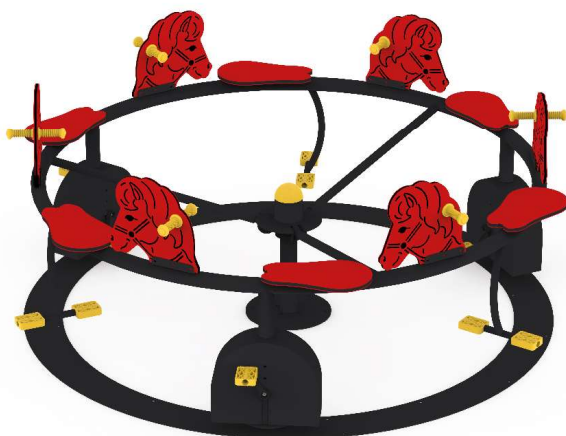

PC-D02

Age Range: 3-14
Number Of Users: 6+
Product Dimensions: Ø216X100cm

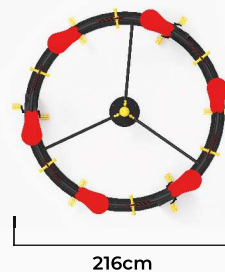

PC-D03

Age Range: 3-14
Number Of Users: 6+
Product Dimensions: Ø185X60cm





PC-D04

Age Range: 3-14
Number Of Users: 4+
Product Dimensions: Ø144X78cm



PC-D05

Age Range: 3-14
Number Of Users: 3+
Product Dimensions: Ø150X100cm



PC-D06

Age Range: 3-14
Number Of Users: 3+
Product Dimensions: Ø150X105cm

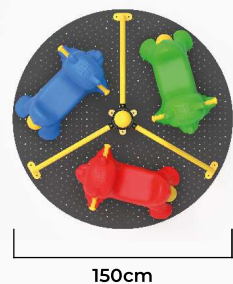



PC-D07

Age Range: 3-14
Number Of Users: 3+
Product Dimensions: Ø205X97cm

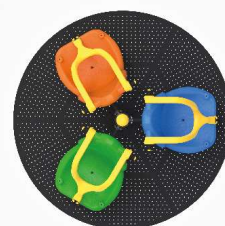

205cm



PC-D08

Age Range: 3-14
Number Of Users: 4+
Product Dimensions: Ø150X87cm

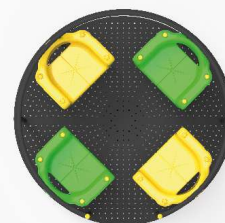

150cm



PC-D09

Age Range: 3-14
Number Of Users: 4+
Product Dimensions: Ø150X105cm

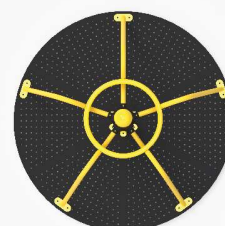

150cm



PC-D10

Age Range: 3-14
Number Of Users: 4+
Product Dimensions: Ø150X86cm

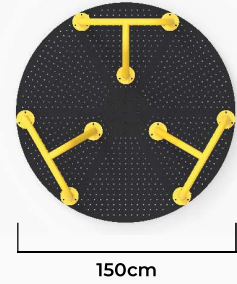

PC-D11

Age Range: 3-14
Number Of Users: 4+
Product Dimensions: Ø120X76cm

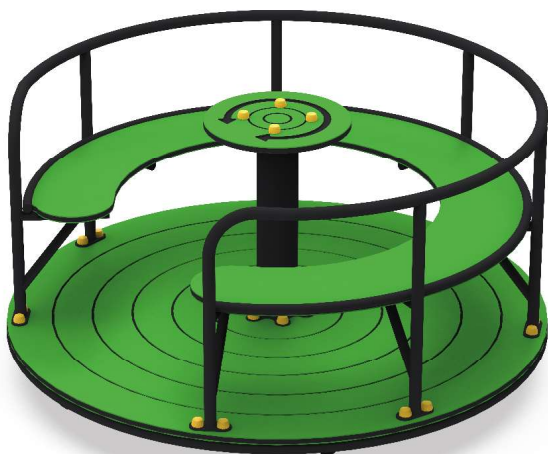

PC-D12

Age Range: 3-14
Number Of Users: 4+
Product Dimensions: Ø150X78cm





PC-D13

Age Range: 3-14

Number Of Users: 3+

Product Dimensions: Ø120X100cm

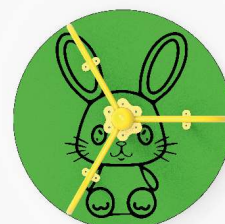

120cm



PC-D14

Age Range: 3-14

Number Of Users: 3+

Product Dimensions: Ø120X80cm



120cm



PC-D15

Age Range: 3-14

Number Of Users: 3+

Product Dimensions: Ø120X147cm

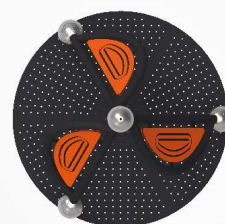

120cm



SWING SERIES

Swings help children develop balance and coordination while also contributing to the development of their motor skills. With modern swings and safe designs, the goal is to reduce the risk of injury for children, giving parents peace of mind.



PC-S01

Age Range: 3-14
 Product Dimensions: 195X135X270cm
 Safety Area: 395X535cm
 Free-Fall Height: 40cm

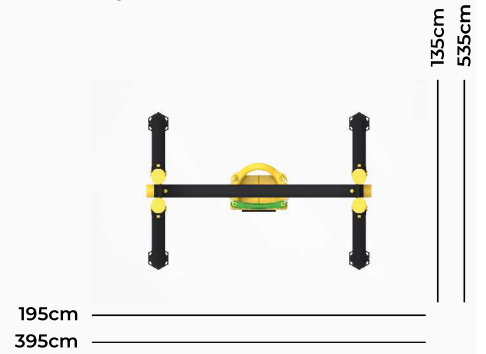

PC-S02

Age Range: 3-14
 Product Dimensions: 195X135X270cm
 Safety Area: 395X535cm
 Free-Fall Height: 40cm

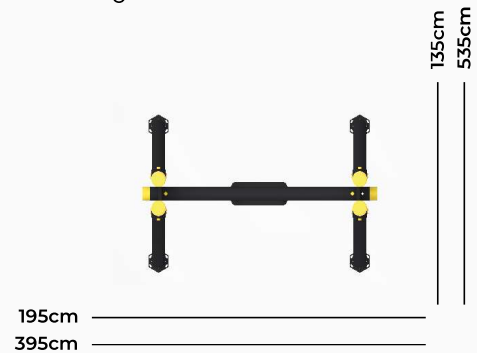

PC-S03

Age Range: 3-14
 Product Dimensions: 195X135X270cm
 Safety Area: 395X535cm
 Free-Fall Height: 40cm

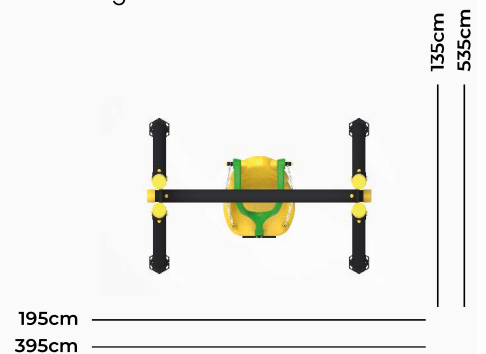



PC-S04

Age Range: 3-14
Product Dimensions: 195X135X270cm
Safety Area: 395X535cm
Free-Fall Height: 40cm

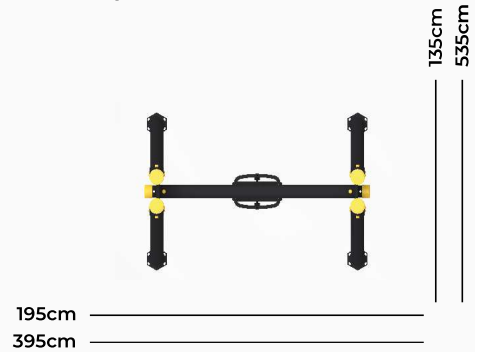

PC-S05

Age Range: 3-14
Product Dimensions: 195X135X270cm
Safety Area: 395X535cm
Free-Fall Height: 70cm

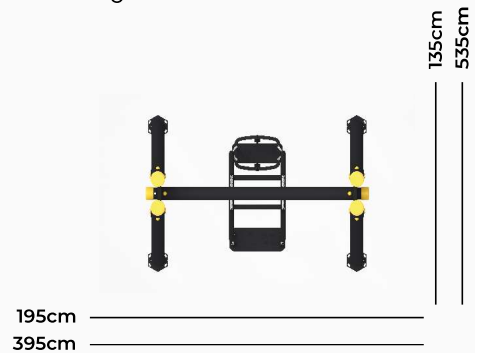

PC-S06

Age Range: 3-14
Product Dimensions: 195X135X270cm
Safety Area: 395X535cm
Free-Fall Height: 45cm

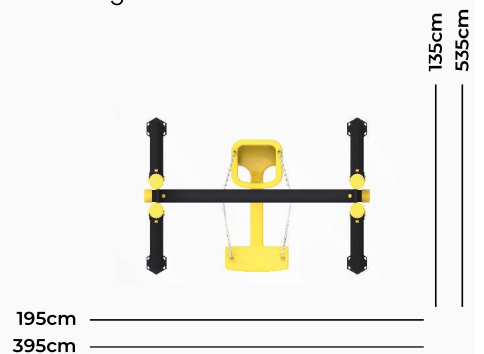



PC-S07

Age Range: 3-14
 Product Dimensions: 315X135X270cm
 Safety Area: 515X535cm
 Free-Fall Height: 45cm

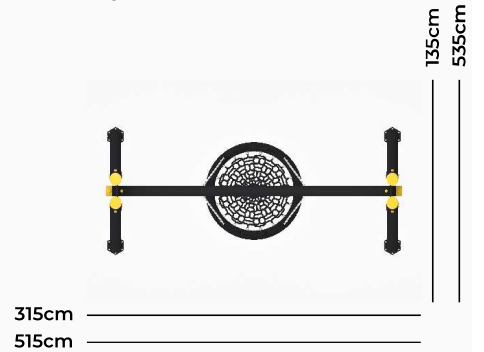

PC-S08

Age Range: 3-14
 Product Dimensions: 315X135X270cm
 Safety Area: 515X535cm
 Free-Fall Height: 45cm

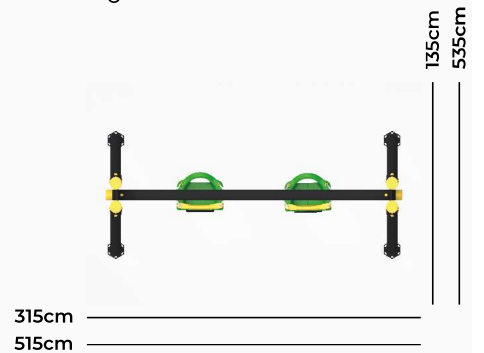

PC-S09

Age Range: 3-14
 Product Dimensions: 315X135X270cm
 Safety Area: 515X535cm
 Free-Fall Height: 43cm

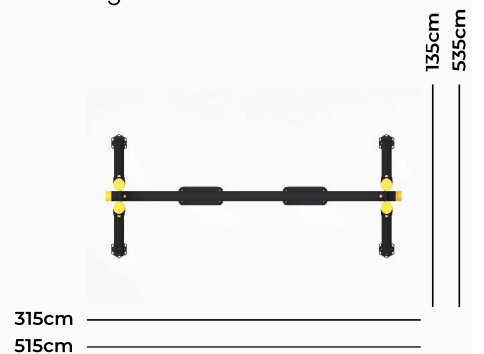



PC-S10

Age Range: 3-14
Product Dimensions: 315X135X270cm
Safety Area: 515X535cm
Free-Fall Height: 45cm

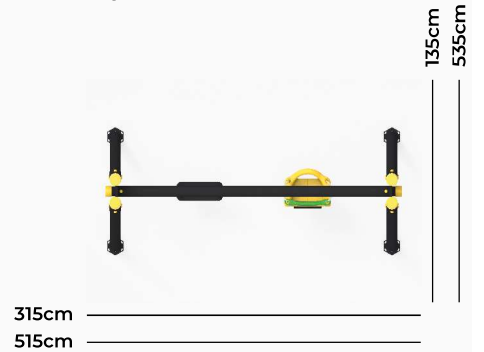

PC-S11

Age Range: 3-14
Product Dimensions: 315X135X270cm
Safety Area: 515X535cm
Free-Fall Height: 50cm

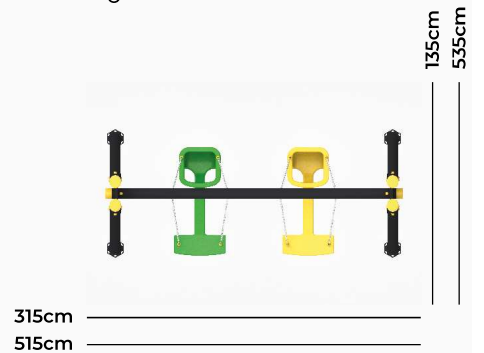

PC-S12

Age Range: 3-14
Product Dimensions: 315X135X270cm
Safety Area: 515X535cm
Free-Fall Height: 45cm

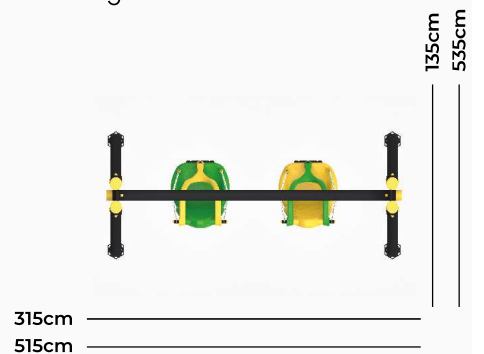



PC-S13

Age Range: 3-14
 Product Dimensions: 515X310X295cm
 Safety Area: 715X700cm
 Free-Fall Height: 45cm

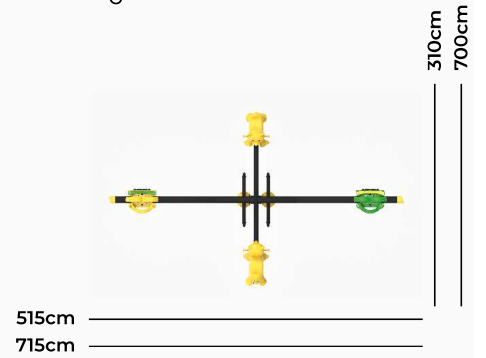

PC-S14

Age Range: 3-14
 Product Dimensions: 490X135X270cm
 Safety Area: 690X535cm
 Free-Fall Height: 45cm

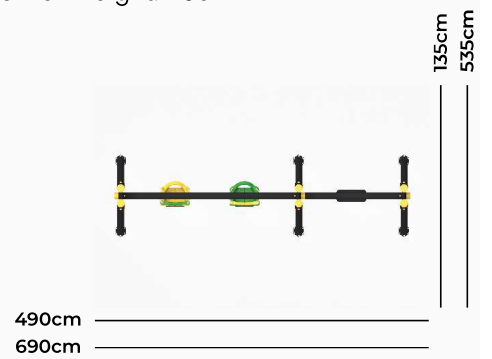

PC-S15

Age Range: 3-14
 Product Dimensions: 605X135X270cm
 Safety Area: 805X535cm
 Free-Fall Height: 45cm

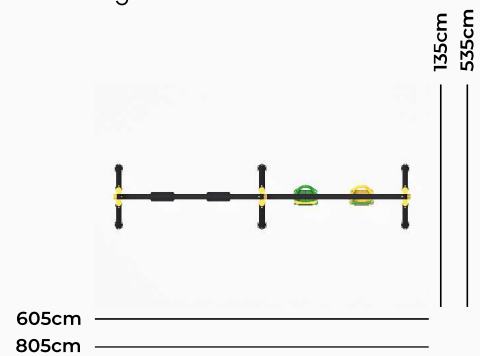



PC-S16

Age Range: 3-14

Product Dimensions: 605X135X270cm

Safety Area: 805X535cm

Free-Fall Height: 55cm



605cm

805cm

135cm
535cm







SEESAW SERIES

Seesaws help children develop their balance and coordination skills while also enhancing their social interaction, communication skills, and self-confidence. Made from durable materials and featuring secure handholds, they are a staple of playgrounds.



PC-B01

Age Range: 3-14
Number Of Users: 2
Product Dimensions: 287X73cm



287cm

73cm



PC-B02

Age Range: 3-14
Number Of Users: 2
Product Dimensions: 296X73cm



296cm

73cm



PC-B03

Age Range: 3-14
Number Of Users: 4
Product Dimensions: 305X73cm



305cm

73cm



PC-B04

Age Range: 3-14
Number Of Users: 2
Product Dimensions: 304X73cm

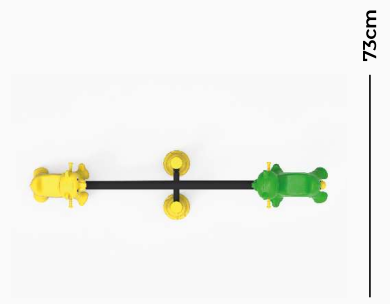

304cm

73cm



PC-B05

Age Range: 3-14
Number Of Users: 2
Product Dimensions: 307X73cm

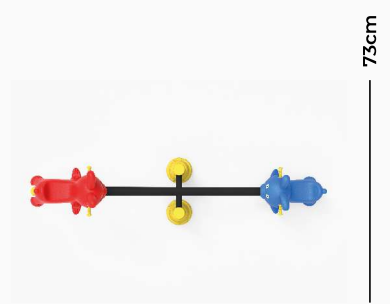

307cm

73cm



PC-B06

Age Range: 3-14
Number Of Users: 4
Product Dimensions: 296X120cm

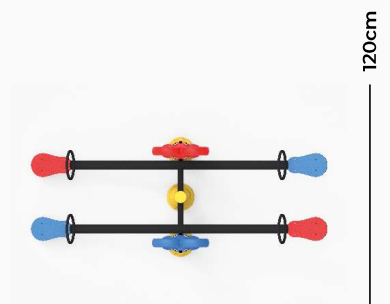

296cm

120cm



PC-B07

Age Range: 3-14

Number Of Users: 4

Product Dimensions: 287X120cm

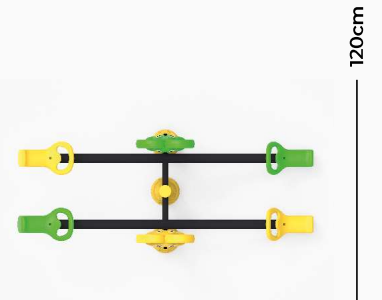

287cm

120cm



PC-B08

Age Range: 3-14

Number Of Users: 4

Product Dimensions: 304X120cm



304cm

120cm



PC-B09

Age Range: 3-14

Number Of Users: 4

Product Dimensions: 307X120cm

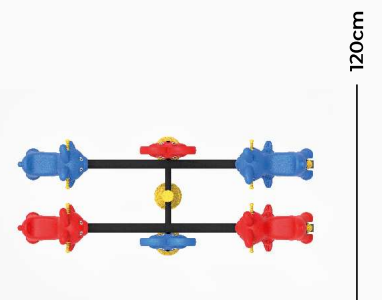

307cm

120cm



PC-B10

Age Range: 3-14
Number Of Users: 2
Product Dimensions: 333X73cm

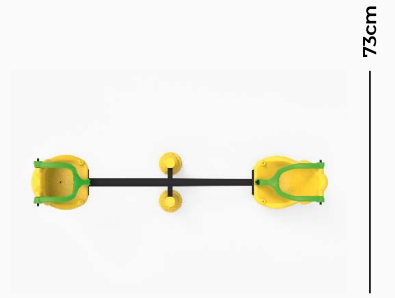

333cm

73cm

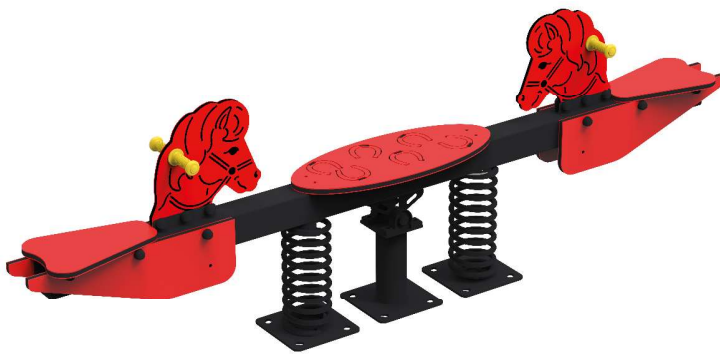

PC-B11

Age Range: 3-14
Number Of Users: 2
Product Dimensions: 316X30cm



316cm

30cm

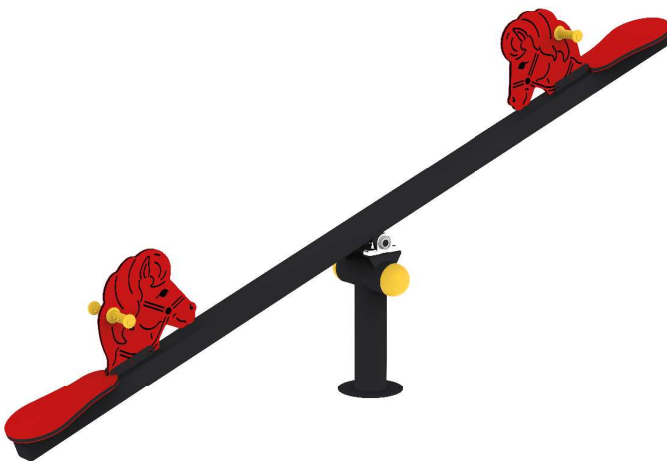

PC-B12

Age Range: 3-14
Number Of Users: 2
Product Dimensions: 286X36cm



286cm

36cm





SPRINGER SERIES

Springer are dynamic, new-generation spring toys that combine balance and excitement for children, stimulating their imaginations. In addition to their safe and colorful appearance, ergonomic handles and sturdy spring systems are designed to keep little ones entertained.



PC-Z01

Age Range: 3-14
Number Of Users: 1
Product Dimensions: 70X46X81cm



70cm

46cm



PC-Z02

Age Range: 3-14
Number Of Users: 1
Product Dimensions: 75X50X87cm



75cm

50cm



PC-Z03

Age Range: 3-14
Number Of Users: 1
Product Dimensions: 115X40X90cm



115cm

40cm



PC-Z04

Age Range: 3-14
Number Of Users: 1
Product Dimensions: 80X45X86cm



PC-Z05

Age Range: 3-14
Number Of Users: 1
Product Dimensions: 100X45X75cm



PC-Z06

Age Range: 3-14
Number Of Users: 1
Product Dimensions: 73X30X75cm

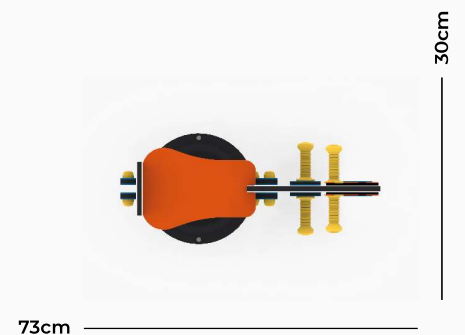

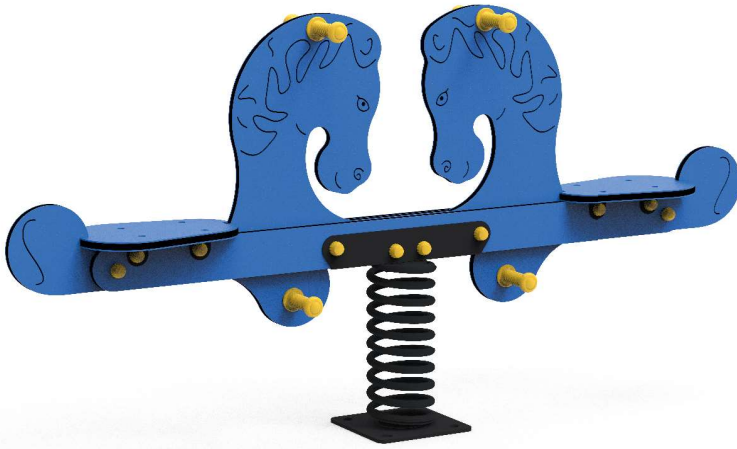

PC-Z07

Age Range: 3-14
Number Of Users: 2
Product Dimensions: 193X42X75cm



PC-Z08

Age Range: 3-14
Number Of Users: 1
Product Dimensions: 102X30X82cm

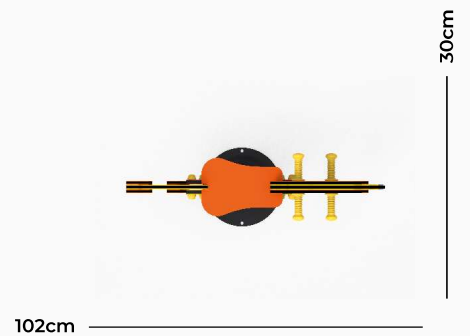

PC-Z09

Age Range: 3-14
Number Of Users: 1
Product Dimensions: 94X30X68cm

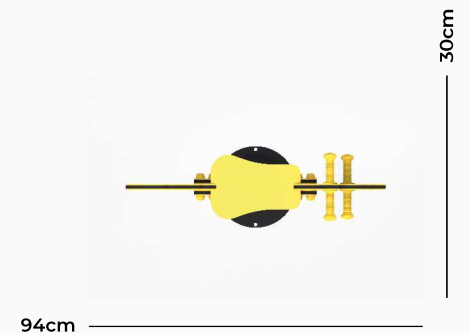



PC-Z10

Age Range: 3-14
Number Of Users: 1
Product Dimensions: 92X92X46cm

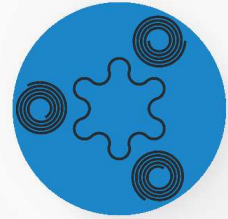

92cm

92cm



PC-Z11

Age Range: 3-14
Number Of Users: 1
Product Dimensions: 86X30X72cm

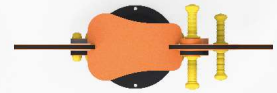

86cm

30cm



PC-Z12

Age Range: 3-14
Number Of Users: 1
Product Dimensions: 109X34X78cm



109cm

34cm



PC-Z13

Age Range: 3-14
Number Of Users: 1
Product Dimensions: 60X38X75cm



60 cm

38cm

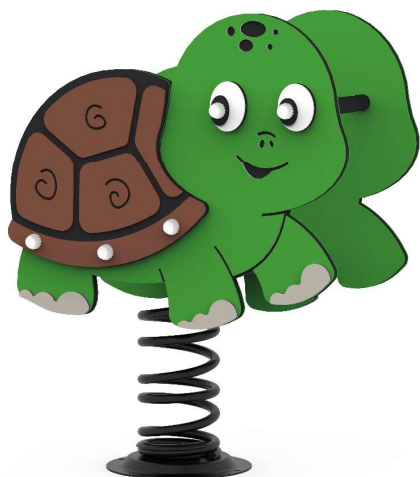

PC-Z14

Age Range: 3-14
Number Of Users: 1
Product Dimensions: 80X38X85cm



80cm

38cm



PC-Z15

Age Range: 3-14
Number Of Users: 1
Product Dimensions: 86X30X73cm



86cm

30cm



PC-Z16

Age Range: 3-14
Number Of Users: 1
Product Dimensions: 95X30X75cm

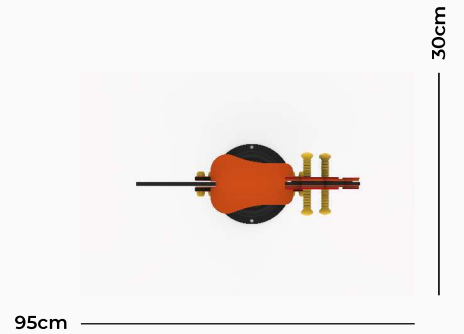

PC-Z17

Age Range: 3-14
Number Of Users: 1
Product Dimensions: 88X30X76cm

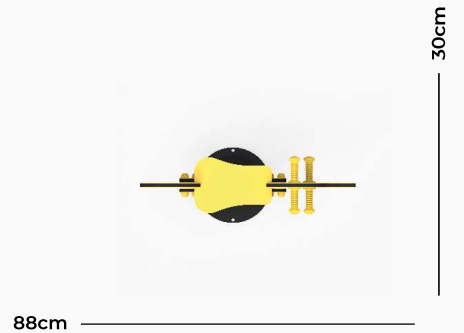

PC-Z18

Age Range: 3-14
Number Of Users: 1
Product Dimensions: 101X40X100cm

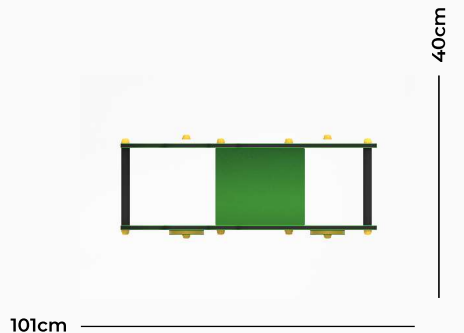



PC-Z19

Age Range: 3-14
Number Of Users: 1
Product Dimensions: 90X40X102cm

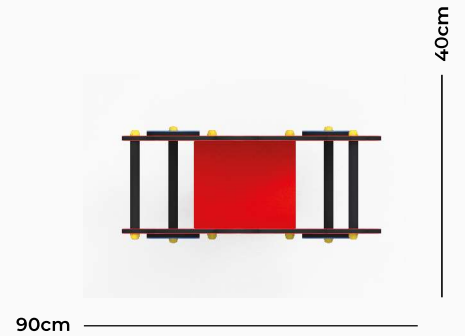

PC-Z20

Age Range: 3-14
Number Of Users: 2
Product Dimensions: 166X30X114cm

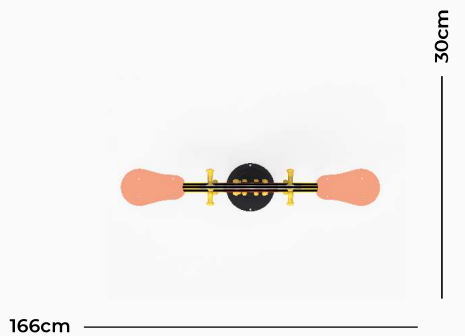

PC-Z21

Age Range: 3-14
Number Of Users: 1
Product Dimensions: 107X100X76cm





PC-Z22

Age Range: 3-14
Number Of Users: 1
Product Dimensions: 98X55X110cm



98cm

55cm

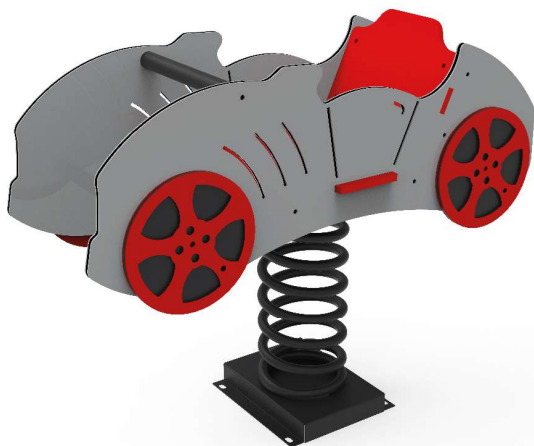

PC-Z23

Age Range: 3-14
Number Of Users: 1
Product Dimensions: 97X35X75cm



97cm

35cm



PC-Z24

Age Range: 3-14
Number Of Users: 2
Product Dimensions: 163X70X140cm



163cm

70cm

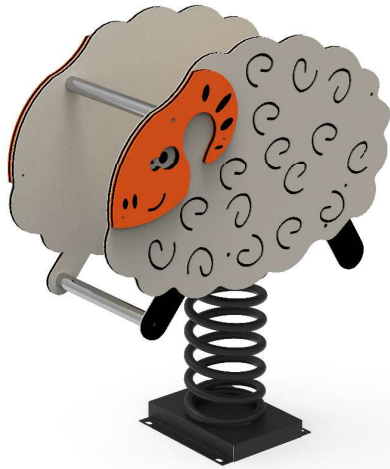

PC-Z25

Age Range: 3-14
Number Of Users: 1
Product Dimensions: 76X30X93cm

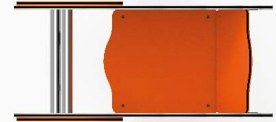

76cm

30cm

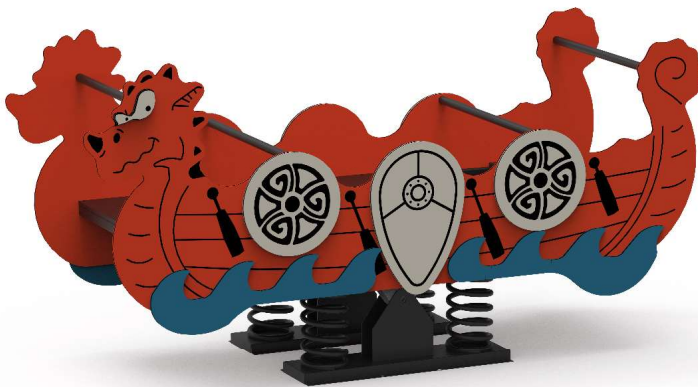

PC-Z26

Age Range: 3-14
Number Of Users: 4+
Product Dimensions: 248X85X124cm



248cm

124cm



PC-Z27

Age Range: 3-14
Number Of Users: 1
Product Dimensions: 75X34X92cm



75cm

34cm



CLIMBING SERIES

The Climbing Series offers children active play experiences through its dynamic design, which supports physical development.

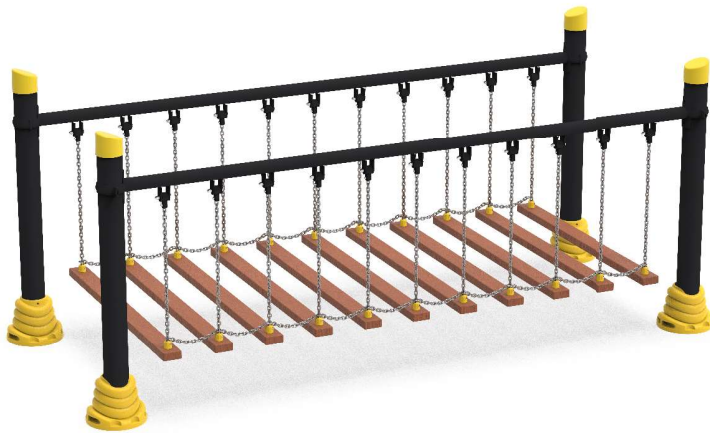

PC-Y01

Age Range: 3-14
 Number Of Users: 5+
 Product Dimensions: 328X146X136cm
 Free-Fall Height: 25cm



328cm

146cm



PC-Y02

Age Range: 3-14
 Number Of Users: 4+
 Product Dimensions: 412X85X203cm
 Free-Fall Height: 203cm



412cm

85cm



PC-Y03

Age Range: 3-14
 Number Of Users: 3+
 Product Dimensions: 292X143X251cm
 Free-Fall Height: 140cm

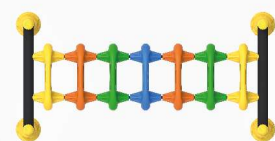

292cm

143cm

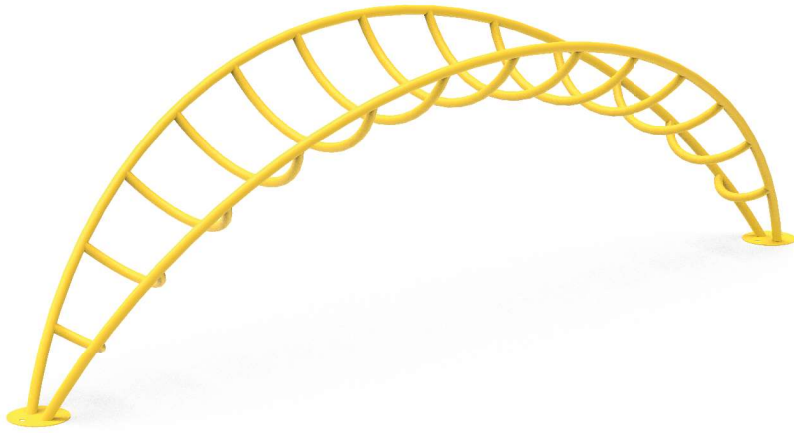

PC-Y04

Age Range: 3-14
 Number Of Users: 3+
 Product Dimensions: 345X83X102cm
 Free-Fall Height: 102cm

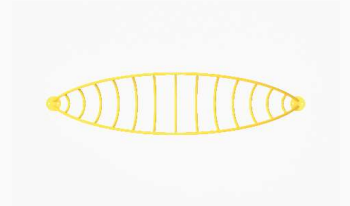

345cm

83cm



PC-Y05

Age Range: 3-14
 Number Of Users: 3+
 Product Dimensions: 320X136X256cm
 Free-Fall Height: 140cm

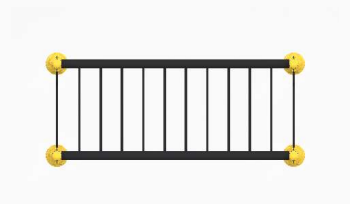

320cm

136cm







TRAMPOLINE SERIES

Trampolines are a fun and beneficial activity that helps children build muscle strength and endurance while improving balance and coordination. Trampolines equipped with safety nets and set up on a soft surface are a favorite among children thanks to their sturdy and modern design.



PC-Y06

Age Range: 3-14
Product Dimensions: Ø180cm



PC-Y07

Age Range: 3-14
Product Dimensions: Ø200cm

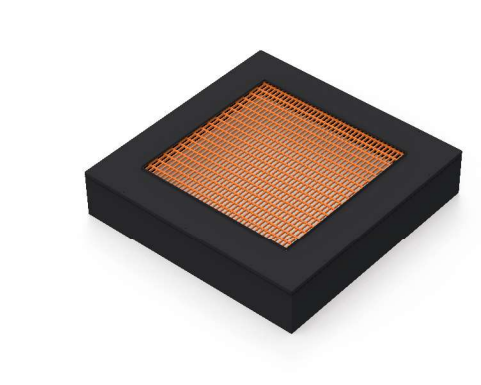
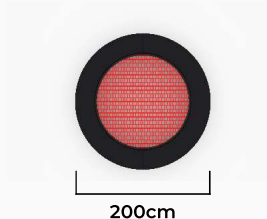

PC-Y08

Age Range: 3-14
Product Dimensions: Ø180cm

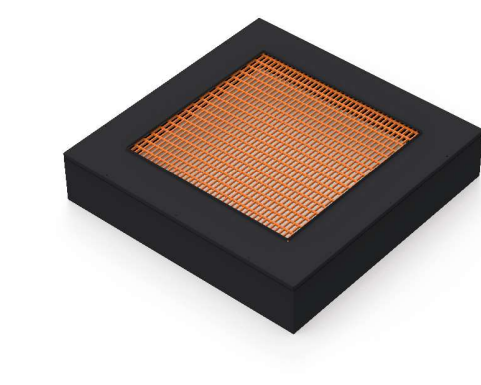
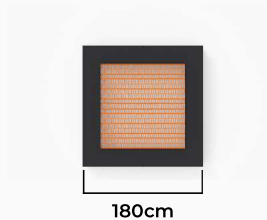

PC-Y09

Age Range: 3-14
Product Dimensions: Ø200cm

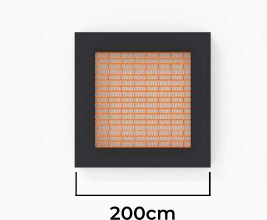



SURVIVOR SERIES

The Survivor Series offers an active play experience with its endurance and challenge focused design. Featuring climbing nets, balance courses, and moving elements, it is designed to help children strengthen their motor skills and balance.



PS-01

Age Range: 3-14
 Number Of Users: 12+
 Product Dimensions: 867X782X268cm
 Safety Area: 1167X1132cm
 Free-Fall Height: 207cm

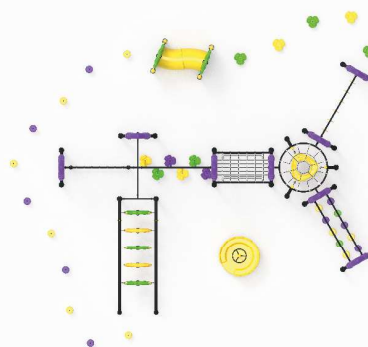

782cm
1132cm

867cm _____
 1167cm _____



PS-02

Age Range: 3-14
 Number Of Users: 6+
 Product Dimensions: 346X338X268cm
 Safety Area: 646X688cm
 Free-Fall Height: 207cm

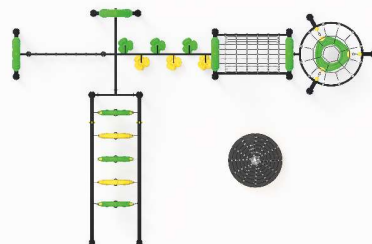

338cm
688cm

346cm
646cm





+90 530 771 71 49
+90 530 185 67 89
info@playsan.com
www.playsan.com

OSB Mh. Yaylacık Cd. No: 34
Selçuklu/Konya/TURKEY