



Product Catalog

2026

Urban Furniture

Discover Playsan's New Urban Furniture
2026 Catalog



+90 530 771 71 49
+90 530 185 67 89



www.playsan.com



Büyükayacak OSB,
Yaylacık Cd. No:34,
42210 Selçuklu/Konya



PLAYSAN PLAYGROUNDS

Design, Security and Entertainment All in One

Playsan is a playground equipment manufacturer that combines an engineering perspective with the world of children.

From design to production, the company prioritizes quality, safety, and sustainability throughout every stage of the process. Today, Playsan products—the preferred choice in many countries—provide children with safe play areas while enhancing the aesthetic appeal of cities.

Each project is specially designed and meticulously crafted to nurture children's imagination. With its innovative solutions and eco-friendly materials, Playsan creates not only playgrounds but also living spaces that add value to communities.

By prioritizing safety and quality in every detail, it offers unforgettable experiences for both children and families.



Games that reach around the world

At Playsan, with our export capabilities extending to over 40 countries, we confidently deliver playground equipment to the world. The playgrounds we produce—tailored to different geographies while maintaining consistent quality, safety, and design standards—form the foundation of our global brand vision.

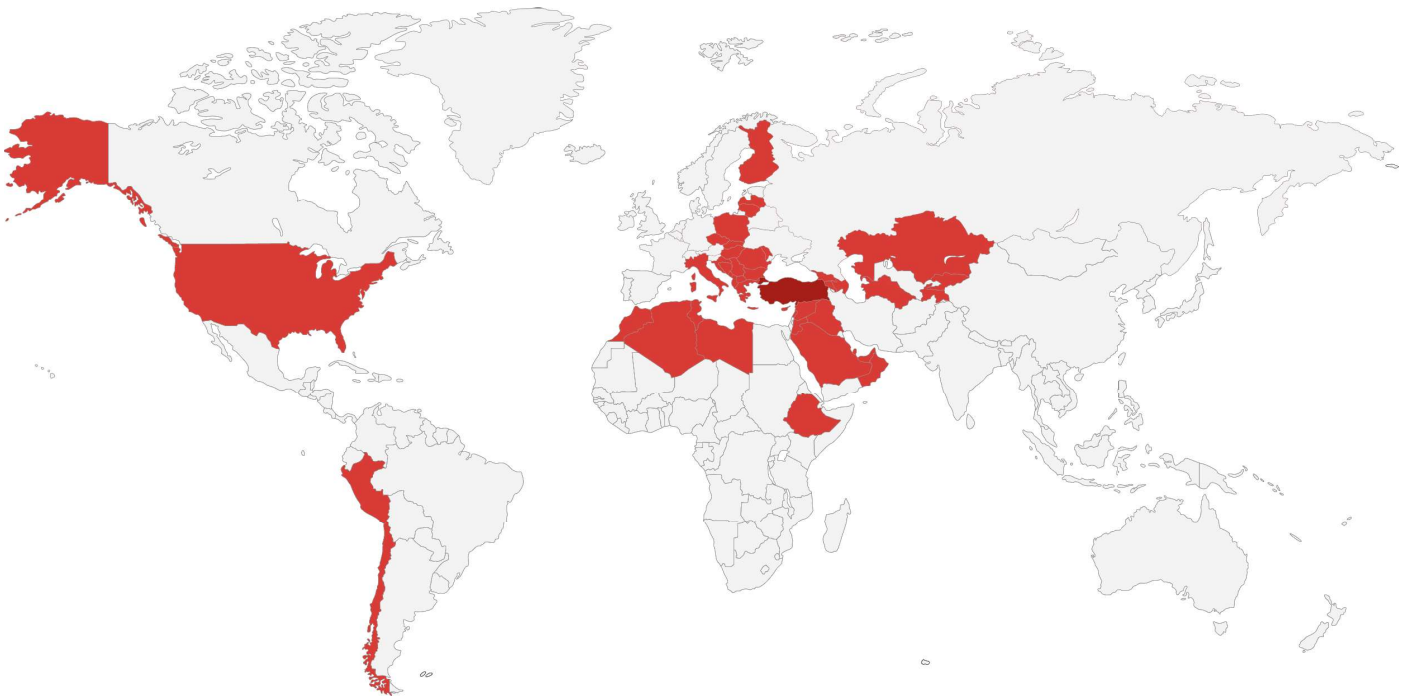

Albania
Azerbaijan
United Arab Emirates
Bosnia And Herzegovina
Bulgaria
Czech Republic
Ethiopia
Morocco
Peru

Finland
Georgia
Croatia
Iraq
Italy
Montenegro
Qatar
Kazakhstan

Kyrgyzstan
Kosovo
Latvia
Libya
Lithuania
Lebanon
Hungary
North Macedonia

Malta
Moldova
Poland
Romania
Serbia
Slovakia
Saudi Arabia
Syria

Chile
Tunisia
Turkmenistan
Oman
United States
Jordan
Greece
Tajikistan



Production at International Standards



With our production philosophy centered on quality and safety, we develop our products in accordance with ISO and EN standards. We offer assurance with ISO 9001:2008, ISO 14001:2004, OHSAS 18001:2007, TS EN 1176 series, TS 12427, TS EN 16630 and TSEK certificates.

We manufacture according to international standards.

At Playsan, we conduct all our production processes in accordance with international quality, environmental, and occupational safety standards. Our products are developed with durability, safety, and long-lasting use in mind at every step, from design and production to material selection and final inspection.

With our approach that prioritizes children's safety in playgrounds, we produce solutions compliant with TS EN 1176 standards and offer durable and sustainable products suitable for outdoor conditions. Thanks to our quality management systems, we aim to maintain the same high standard in every project with stable production, controlled processes, and a reliable supply chain.



Our Production Stages



Laser Cutting

This process involves cutting the metal and sheet metal used in our products to the specified standard dimensions.

Sheet Metal Bending

This process involves shaping the sheet metal to be used in playground equipment using a press brake and appropriate dies at specific angles.



MIG Welding

It is a type of welding used to join different parts on metal workbenches.

Sandblasting

It is a surface cleaning method used to remove rust, dirt, grease, and welding slag from metal surfaces. This process is applied to all metal products.



Electrostatic Painting

All metals used in the playground equipment are coated with electrostatic powder paint. This process not only gives the products an attractive appearance but also ensures they remain protected against all weather conditions for many years.

Plastisol Coating

Plastisol coating is used to soften sharp surfaces that children may come into contact with, protect metals from corrosion, and prevent floors from becoming slippery.





Raw Material Line

Pure polyethylene raw material undergoes specific processing steps. Additives and pigments that prevent color fading and provide protection against UV rays are added, and the mixture is homogenized in a mixer to make it ready for production.

Plastic Material Production (Rotational Molding)

The raw materials, once prepared for production, are poured into molds and baked under controlled conditions in rotary kilns to produce the final product.



Router Processing

This involves engraving, shaping, creating reliefs, and etching on materials such as HPL and HDPE.

Woodworking

In our woodworking processes, products such as gazebos, benches, and picnic tables are crafted with a focus on durability and aesthetics. The selected wood materials are shaped using modern woodworking techniques.



Rope and Connection Systems

Rope and Connection Systems; High-strength ropes and connectors are secured using a hydraulic press and joined in a way that cannot be undone.

Shipment

Our products are securely packaged and meticulously prepared throughout the shipping process to ensure they arrive without damage. Supported by a well-structured logistics system, all deliveries are carried out on time and in complete quantities.



Designed for Modern Cities!

Public spaces cater to different needs at every moment of the day.

Whether you're resting, waiting, meeting up, or just taking a moment to pause...

Playsan Urban Furniture offers sturdy, timeless designs that adapt to every need.

Blend into the city.
Stay comfortable.





Contents

OUTDOOR TRASH BINS	10-15
BENCHES AND PICNIC TABLE	16-29
VARIOUS URBAN FURNITURE	30-37
CHESS TABLES	38-39



OUTDOOR TRASH BINS

Trash Bins combine aesthetic design with durable construction to enhance the urban landscape; they stand out for their functional design and long-lasting durability.



PM-01

Product Dimensions: 91X49X102cm

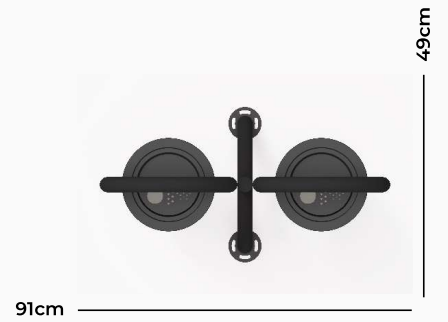

PM-02

Product Dimensions: 49X29X75cm

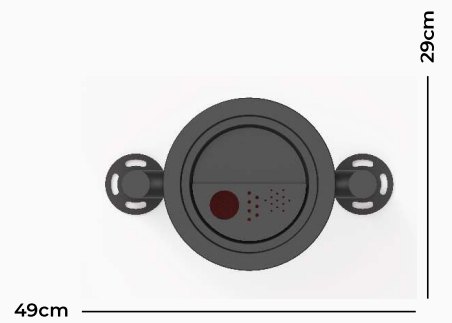

PM-03

Product Dimensions: 49X29X102cm





PM-04

Product Dimensions: 49X46X71cm



PM-05

Product Dimensions: 82X43X106cm



PM-06

Product Dimensions: 49X49X102cm

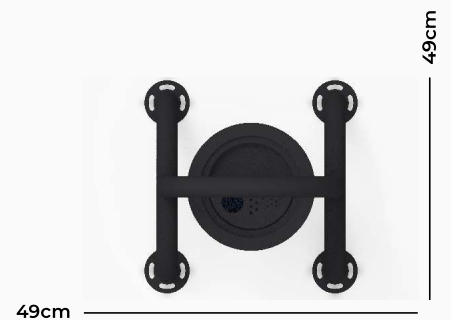



PM-07

Product Dimensions: 46X29X76cm

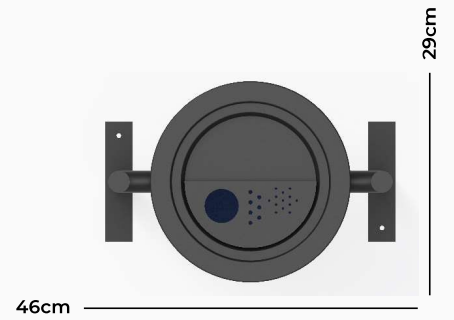

PM-08

Product Dimensions: 48X45X100cm



PM-09

Product Dimensions: 56X40X100cm

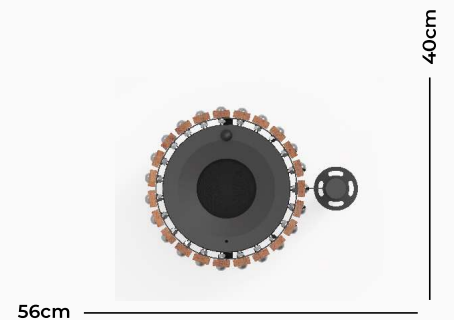



PM-10

Product Dimensions: 100X40X102cm

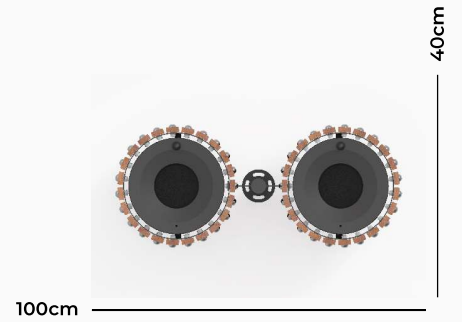

PM-11

Product Dimensions: 49X43X97cm



PM-12

Product Dimensions: 48X48X65cm

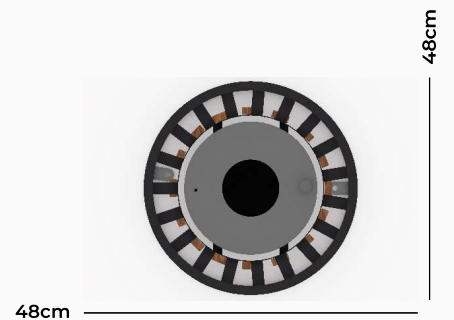



PM-13

Product Dimensions: 53X53X62cm

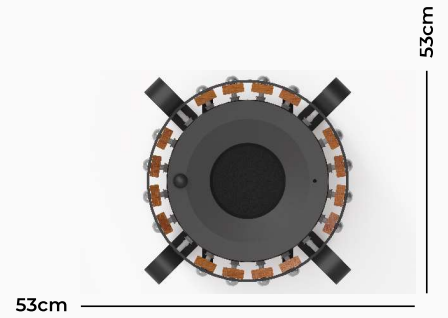

PM-14

Product Dimensions: 40X40X82cm

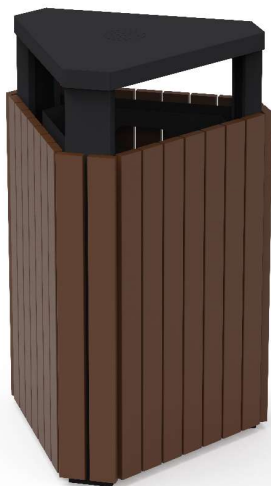
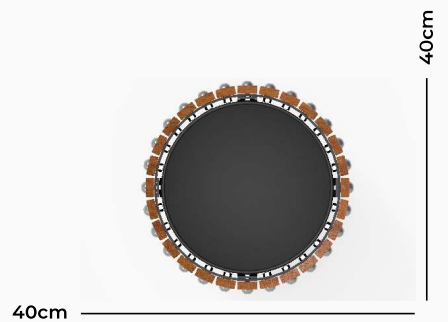

PM-15

Product Dimensions: 62X54X95cm

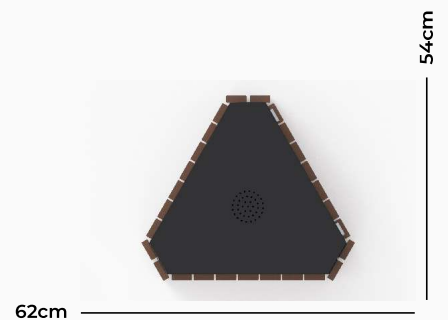



BENCHES AND PICNIC TABLES

Benches and picnic tables enhance the value of social spaces by combining comfort and durability with modern design; with their ergonomic construction and aesthetic appeal, they offer long-lasting solutions.



PM-16

Number Of Users: 3

Product Dimensions: 170X45X45cm

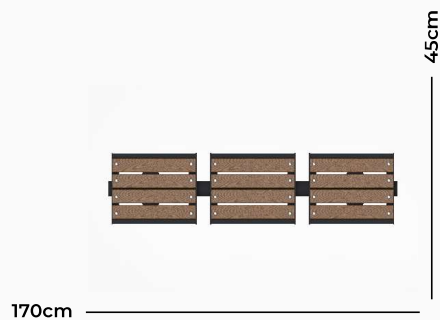

PM-17

Number Of Users: 3

Product Dimensions: 148X40X45cm

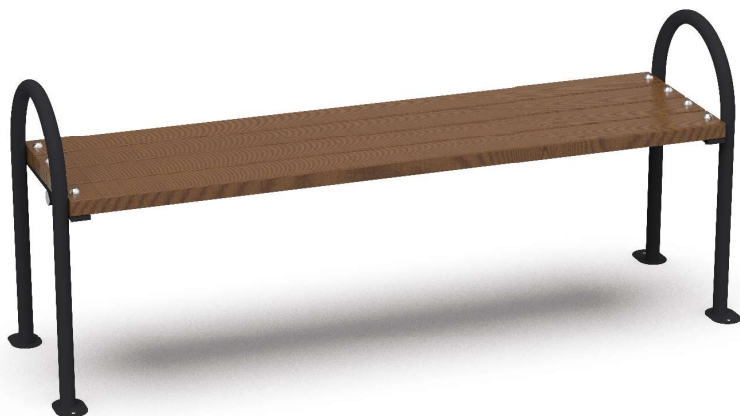

PM-18

Number Of Users: 3

Product Dimensions: 145X48X45cm

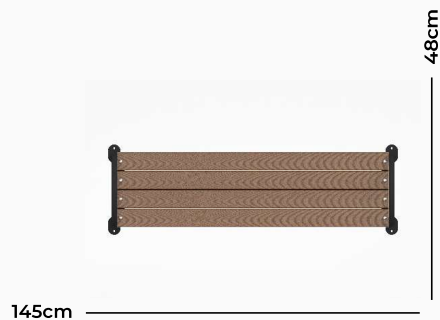



PM-19

Number Of Users: 3

Product Dimensions: 145X40X45cm

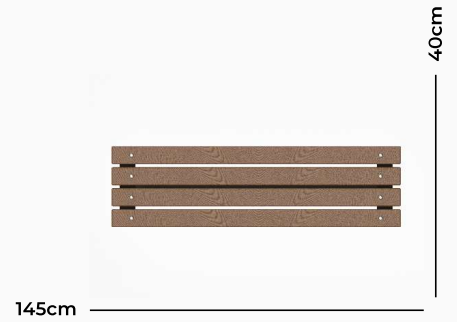

PM-20

Number Of Users: 3

Product Dimensions: 150X48X45cm

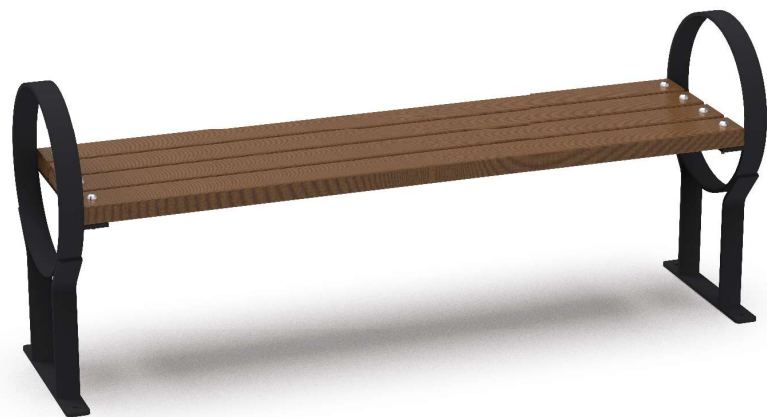

PM-21

Number Of Users: 3

Product Dimensions: 155X40X45cm

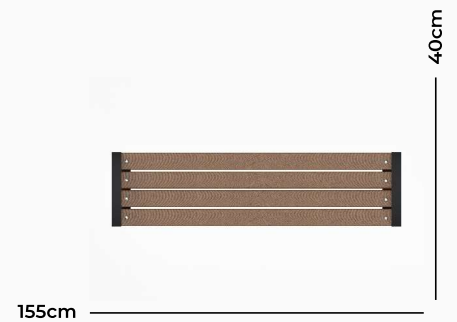



PM-22

Number Of Users: 3
Product Dimensions: 160X55X85cm

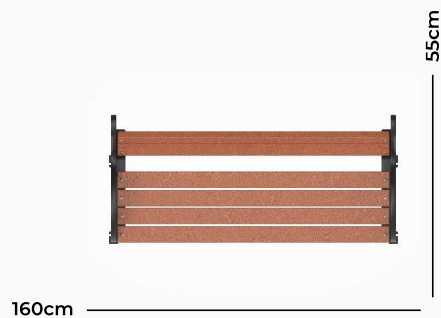

PM-23

Number Of Users: 3
Product Dimensions: 160X55X85cm



PM-24

Number Of Users: 3
Product Dimensions: 155X52X78cm





PM-25

Number Of Users: 3
Product Dimensions: 160X55X85cm

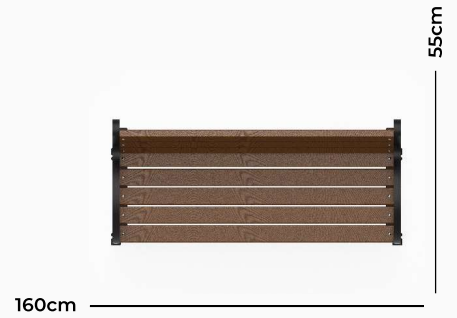

PM-26

Number Of Users: 3
Product Dimensions: 160X55X85cm



PM-27

Number Of Users: 3
Product Dimensions: 160X55X85cm





PM-28

Number Of Users: 3
Product Dimensions: 145X63X80cm

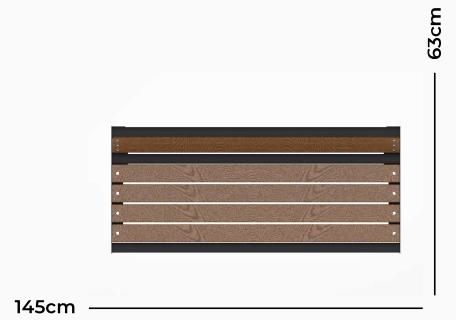

PM-29

Number Of Users: 3
Product Dimensions: 165X66X85cm



PM-30

Number Of Users: 3
Product Dimensions: 155X52X86cm





PM-31

Number Of Users: 3
Product Dimensions: 145X53X81cm



PM-32

Number Of Users: 3
Product Dimensions: 145X51X82cm

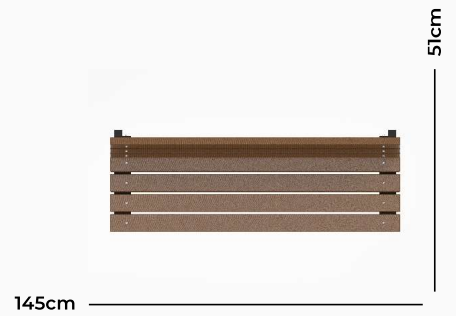

PM-33

Number Of Users: 3
Product Dimensions: 155X51X78cm

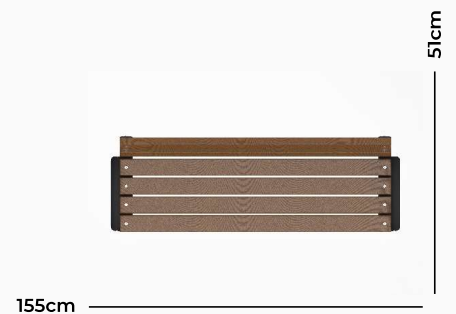



PM-34

Number Of Users: 3
Product Dimensions: 145X52X73cm

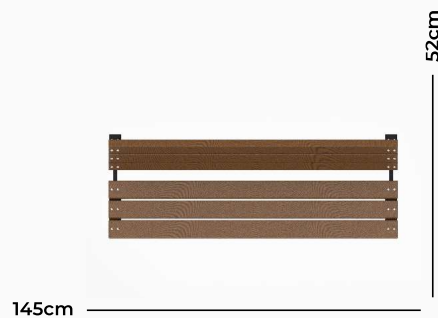

PM-35

Number Of Users: 3
Product Dimensions: 152X76X80cm

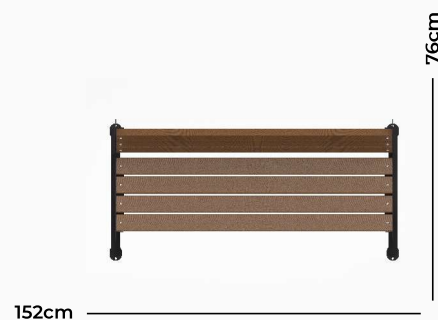

PM-36

Number Of Users: 3
Product Dimensions: 160X55X85cm





PM-37

Number Of Users: 3
Product Dimensions: 145X62X80cm



PM-38

Number Of Users: 4
Product Dimensions: 220X58X86cm



PM-39

Number Of Users: 4
Product Dimensions: 250X58X82cm





PM-40

Number Of Users: 5

Product Dimensions: 250X54X45cm

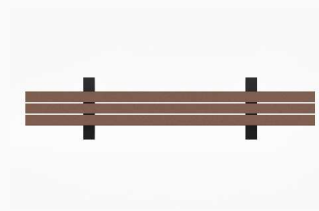

250cm

54cm



PM-41

Number Of Users: 4

Product Dimensions: 200X65X82cm



200cm

65cm



PM-42

Number Of Users: 3

Product Dimensions: 145X48X80cm



145cm

48cm



PM-43

Number Of Users: 3
Product Dimensions: 157X57X73cm

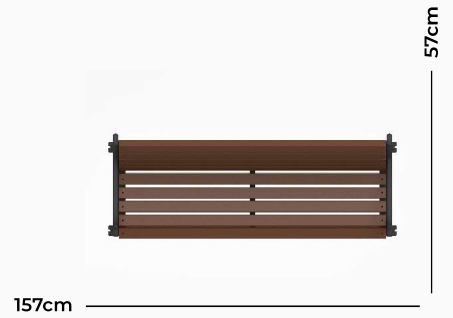

PM-44

Number Of Users: 8
Product Dimensions: 370X50X50cm

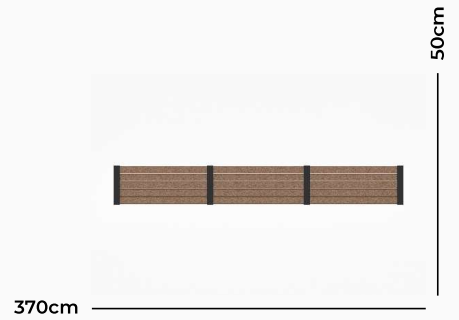

PM-45

Number Of Users: 12
Product Dimensions: 280X254X76cm





PM-46

Number Of Users: 8
Product Dimensions: 218X218X77cm

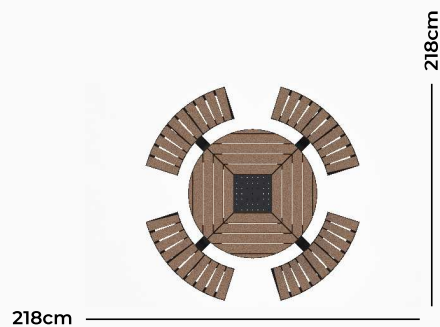

PM-47

Number Of Users: 6
Product Dimensions: 180X162X75cm



PM-48

Number Of Users: 6
Product Dimensions: 230X145X84cm

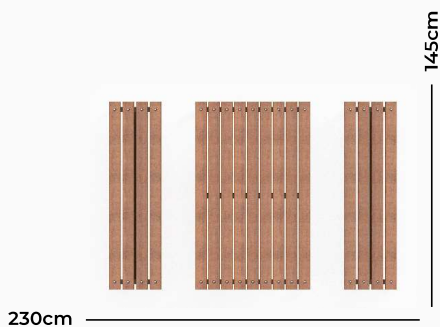



PM-49

Number Of Users: 6

Product Dimensions: 254X145X84cm



PM-50

Number Of Users: 6

Product Dimensions: 155X145X83cm

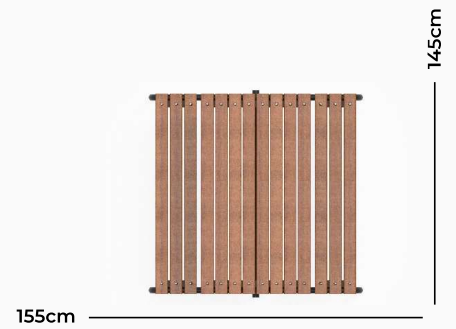

PM-51

Number Of Users: 6

Product Dimensions: 205X145X75cm

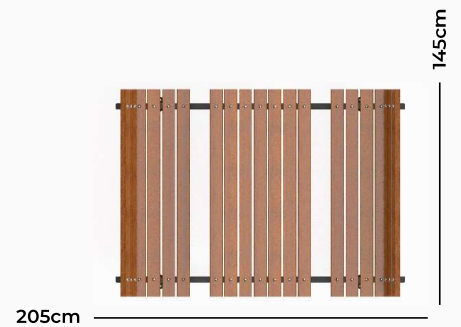



PM-52

Number Of Users: 8

Product Dimensions: 285X230X84cm

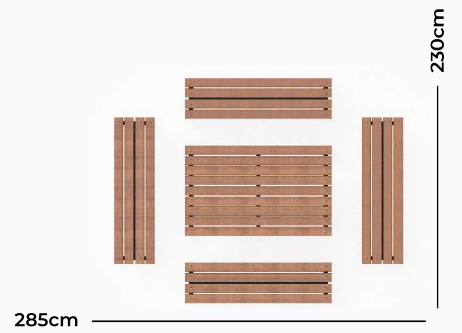



VARIOUS URBAN FURNITURE

Various Urban Furniture offers solutions tailored to various needs particularly gazebos with a modern design approach; its durable construction and aesthetic details enhance living spaces.



PM-53

Number Of Users: 3
Product Dimensions: 211X167X255cm



PM-54

Number Of Users: 3
Product Dimensions: 220X97X250cm

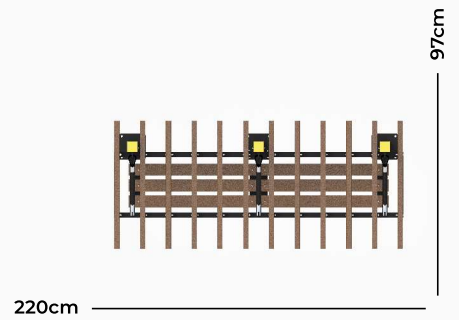

PM-55

Number Of Users: 6
Product Dimensions: 417X95X75cm

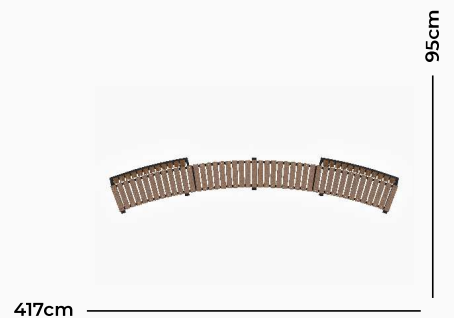



PM-56

Number Of Users: 12

Product Dimensions: 802X197X77cm



802cm

197cm



PM-57

Number Of Users: 9

Product Dimensions: 669X195X228cm



669cm

195cm



PM-58

Number Of Users: 18

Product Dimensions: 1236X355X229cm



1236cm

355cm



PM-59

Number Of Users: 30
Product Dimensions: 484X484X43cm

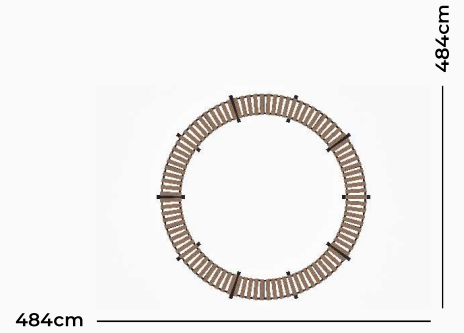

PM-60

Number Of Users: 6
Product Dimensions: 288X256X250cm



PM-61

Number Of Users: 9
Product Dimensions: 500X95cm





PM-62

Number Of Users: 9
Product Dimensions: 455X138cm

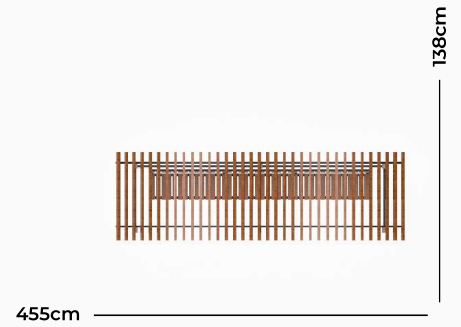

PM-63

Number Of Users: 6
Product Dimensions: 224X197X227cm



PM-64

Number Of Users: 14+
Product Dimensions: 300X300cm
400X400cm

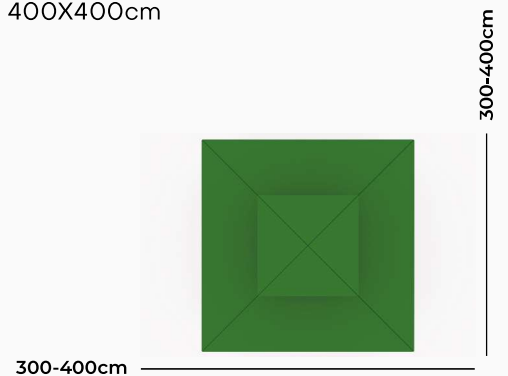



PM-65

Number Of Users: 14+
Product Dimensions: 300X300cm
400X400cm

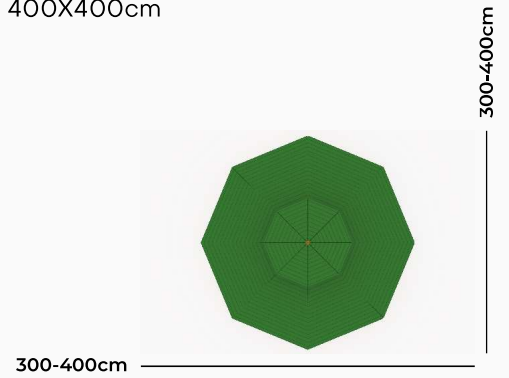

PM-66

Number Of Users: 7
Product Dimensions: 311X89X37cm

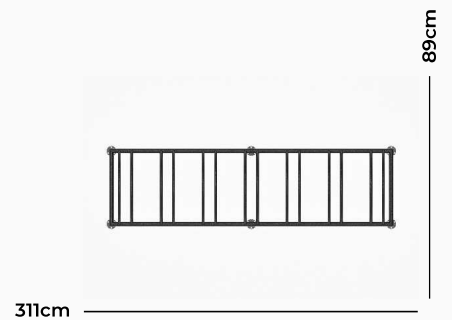

PM-67

Number Of Users: 5
Product Dimensions: 211X89X37cm

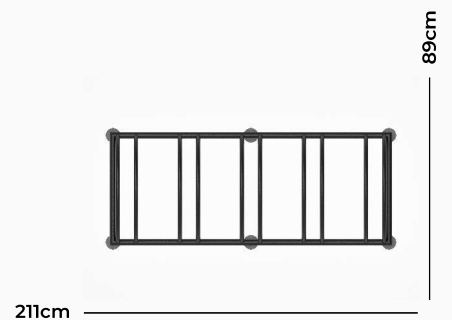



PM-68

Number Of Users: 4

Product Dimensions: 66X21X70cm

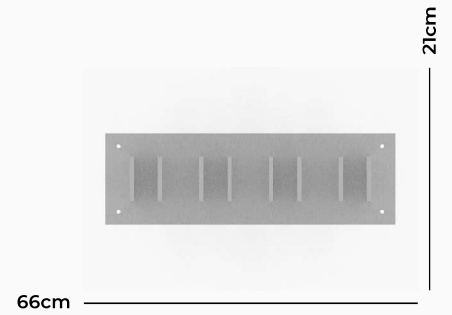





CHESS TABLES

Our chess tables, distinguished by their durable construction and functional design, offer an aesthetic solution that enhances social interaction in open spaces. With their built-in chessboard, they bring people together.



PM-69

Number Of Users: 4

Product Dimensions: 157X157X76cm

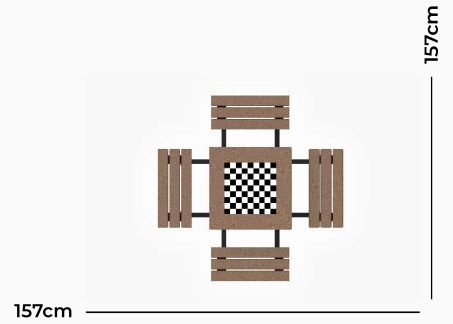

PM-70

Number Of Users: 4

Product Dimensions: 193X157X76cm

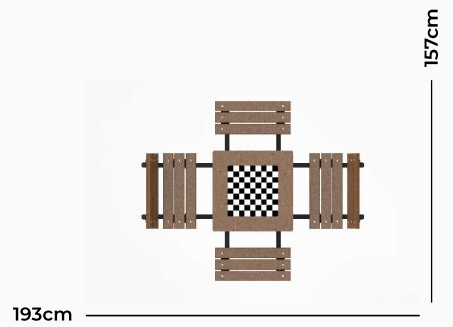



+90 530 771 71 49
+90 530 185 67 89
info@playsan.com
www.playsan.com

OSB Mh. Yaylacık Cd. No: 34
Selçuklu/Konya/TURKEY